

I/B

MAUD BEAUGRAND-BERNARD
ARCHITECTE

18, rue du docteur Roux PARIS 15 maudbeaugrand@hotmail.com 06 20 56 19 72

STRUCTURATION **RESTRUCTURATION** RESTRUCTURA



23, BOULEVARD GAMBETTA BOULOGNE 144 m2 1

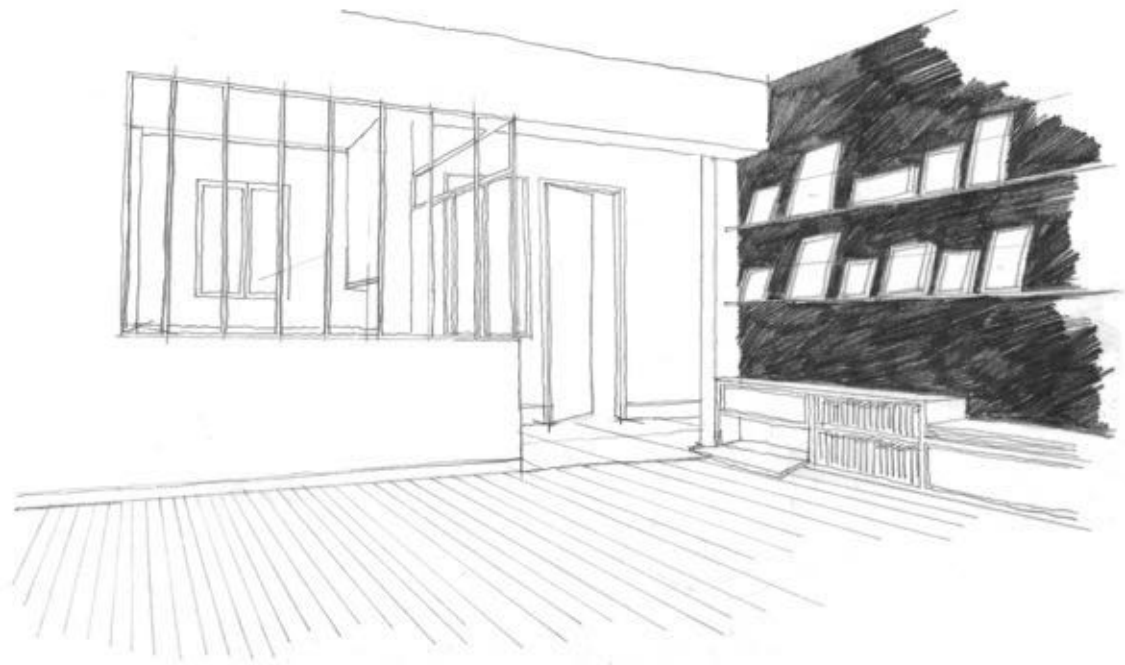

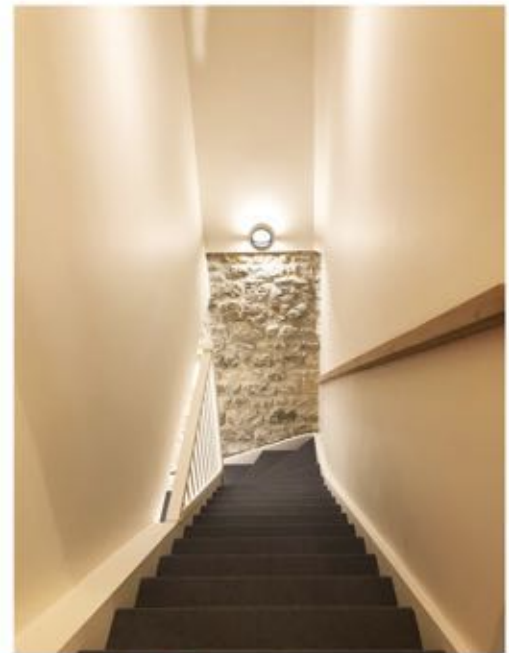
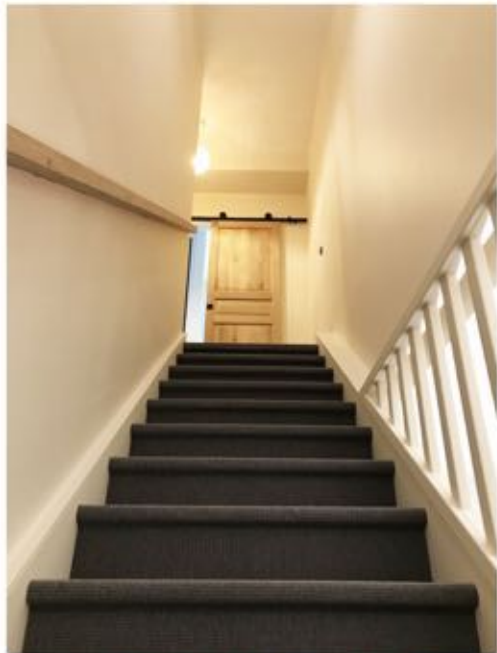

23, BOULEVARD GAMBETTA BOULOGNE 144 m² 2

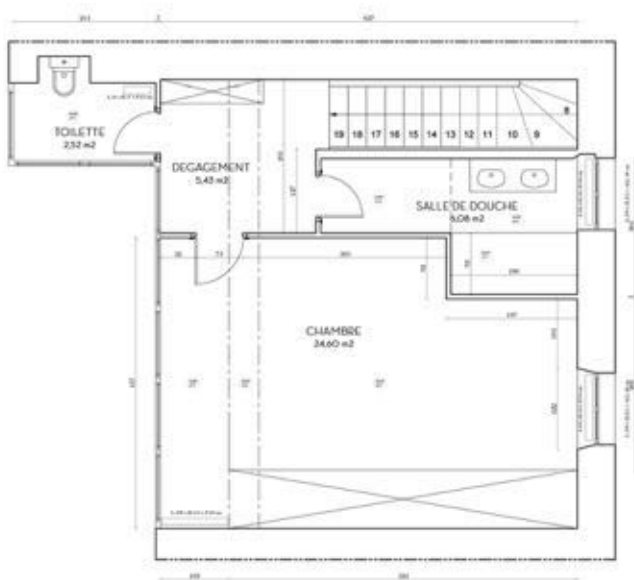

AVANT = 1 CHAMBRE

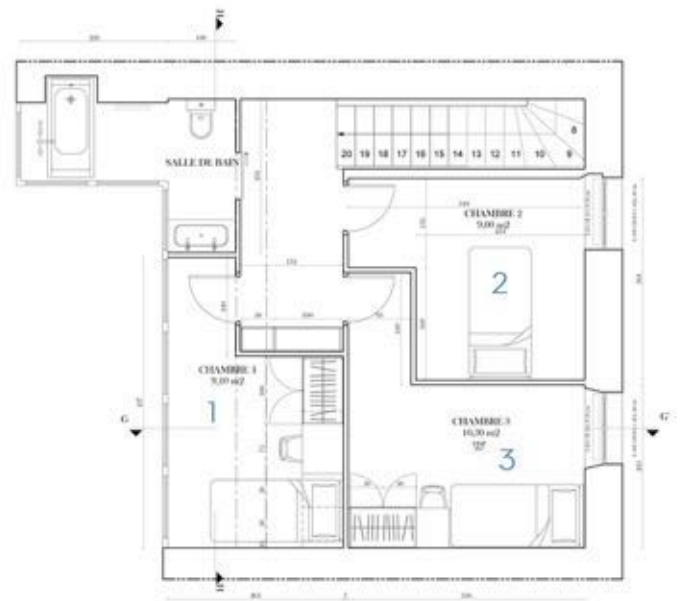

APRES = 1 + 2 + 3 CHAMBRES



23, BOULEVARD GAMBETTA BOULOGNE 144 m2 3





23, BOULEVARD GAMBETTA BOULOGNE 144 m2 4

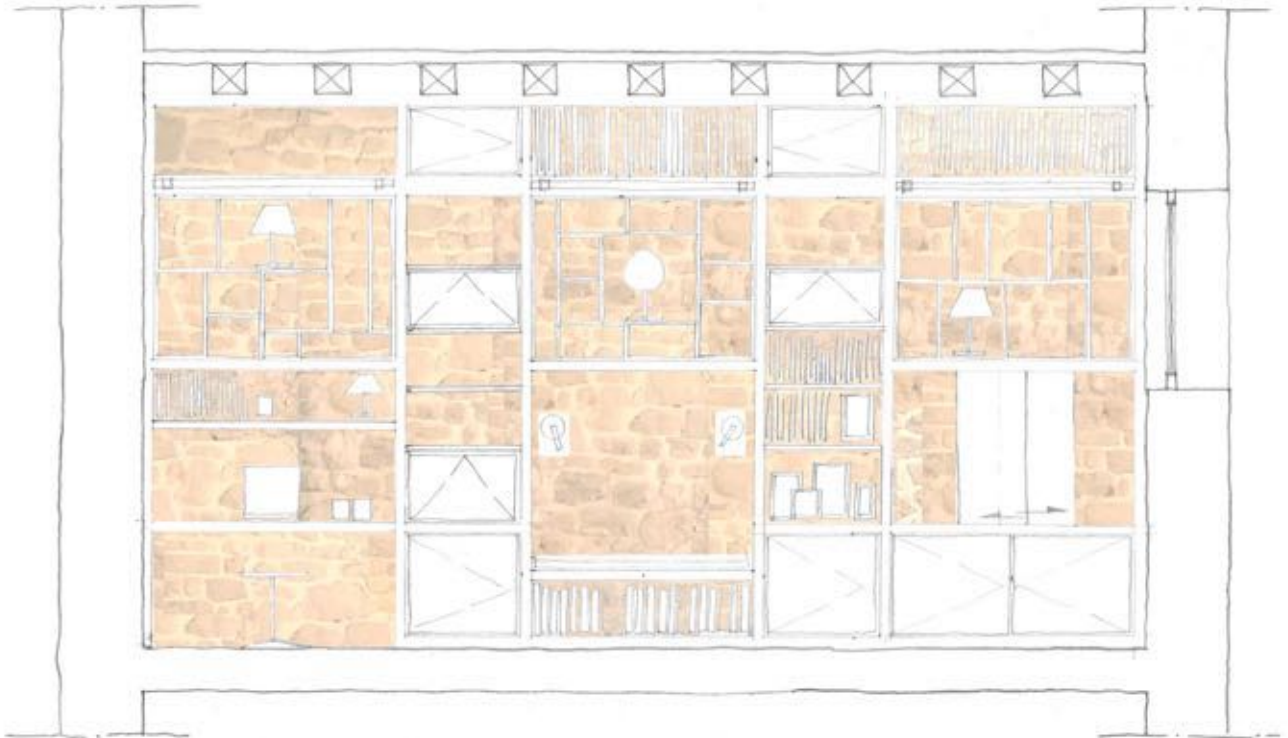



13, HAMEAU MICHEL ANGE PARIS 16ème

1

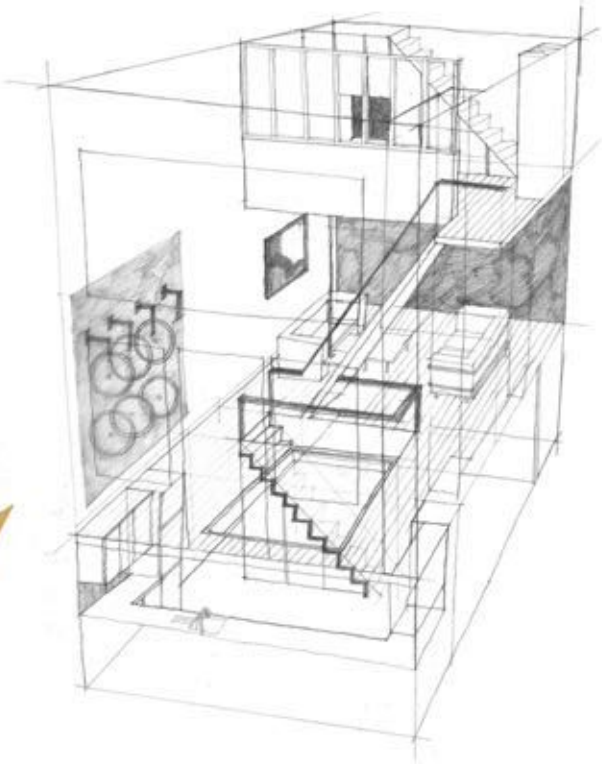

ou

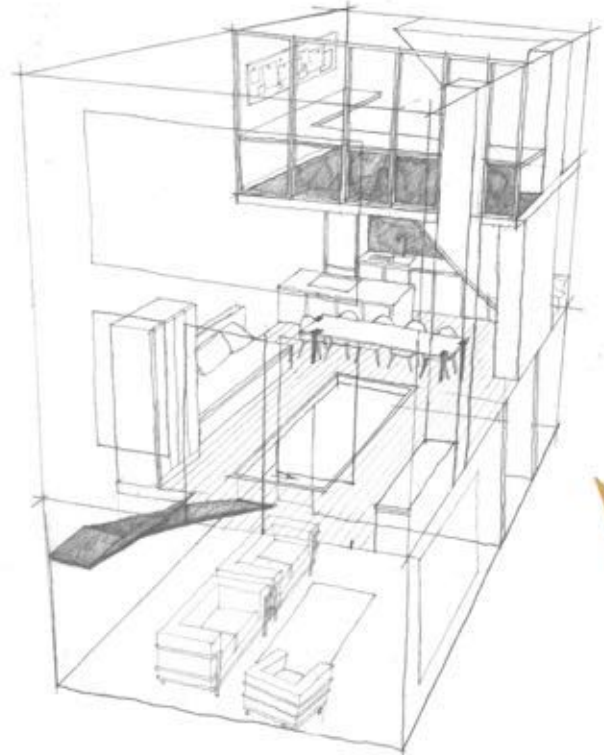

crédit photo: stephane Vasco



13, HAMEAU MICHEL ANGE PARIS 16ème

2

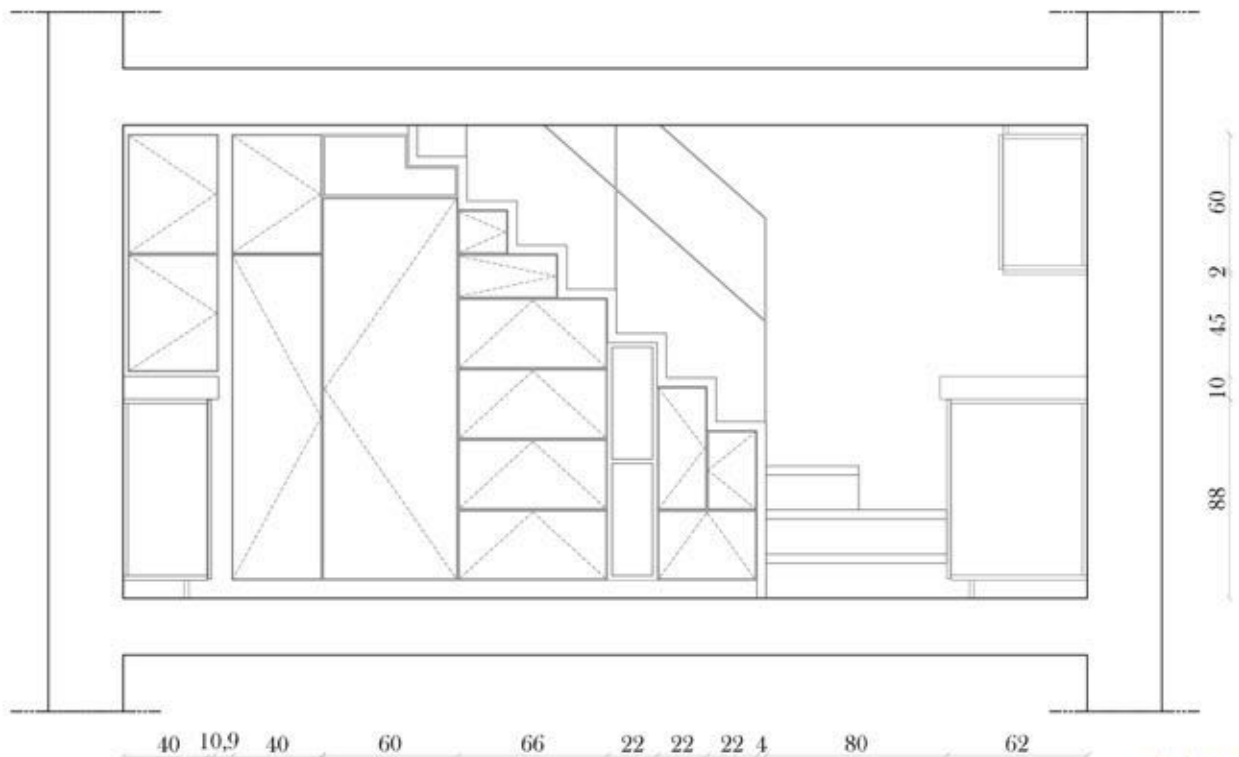

crédit photo: stephane Vasco



13, HAMEAU MICHEL ANGE PARIS 16ème

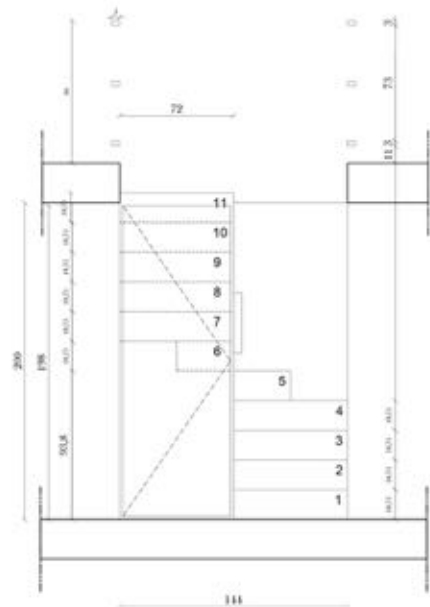
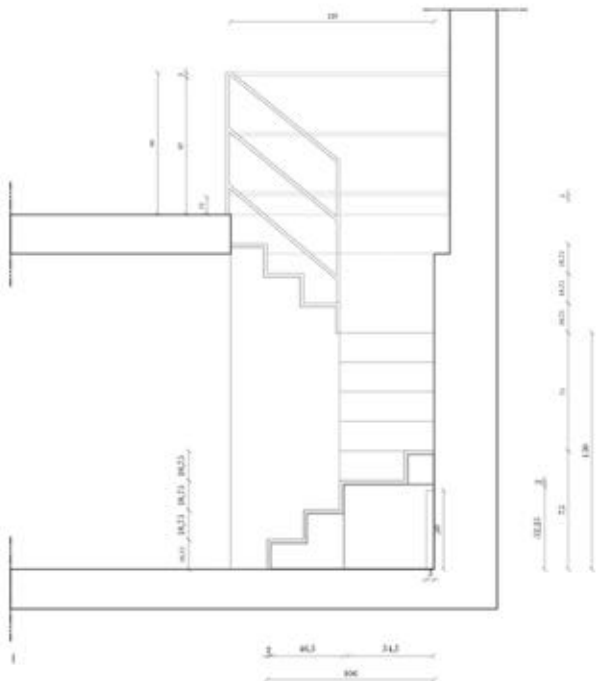

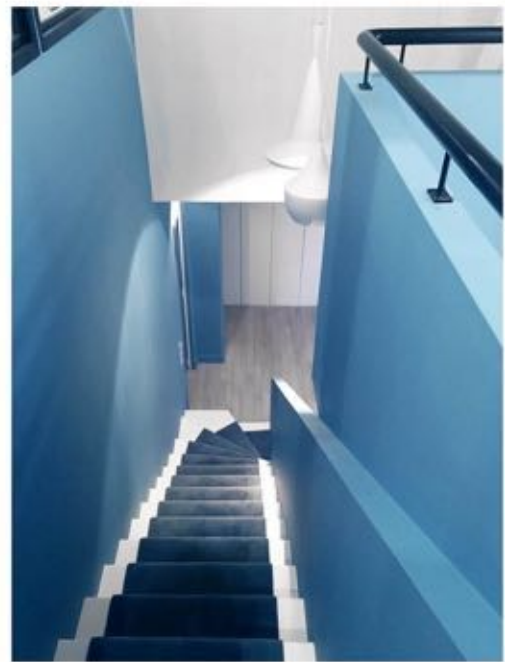

26, RUE VAVIN PARIS 6ème

262 m2

1





26, RUE VAVIN PARIS 6ème

262 m2

2





26, RUE VAVIN PARIS 6ème

262 m2

3





23, RUE POUCHET PARIS 17ème

111 m2 1

1

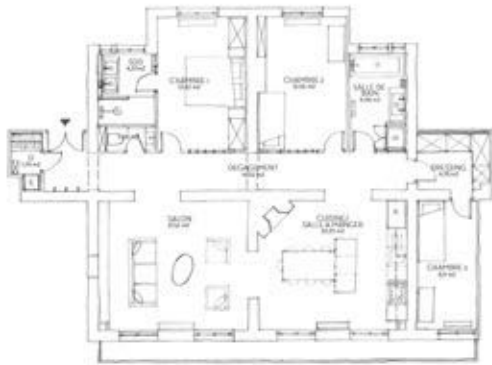

2

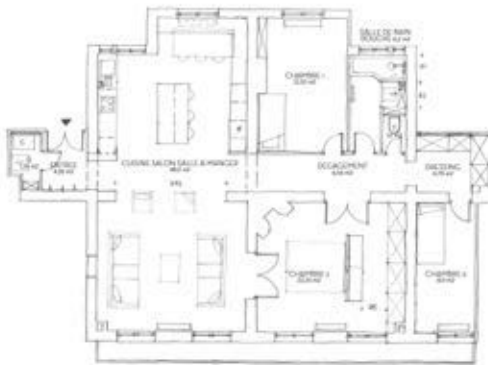

3

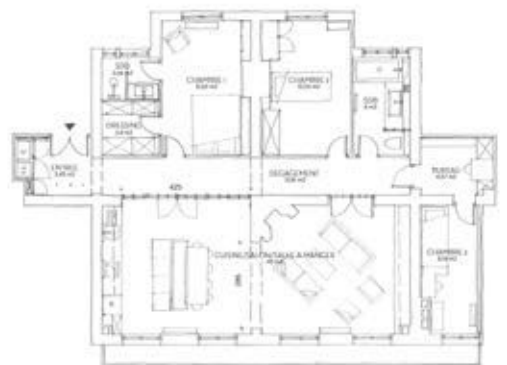

PROPOSITIONS D'ESQUISSE

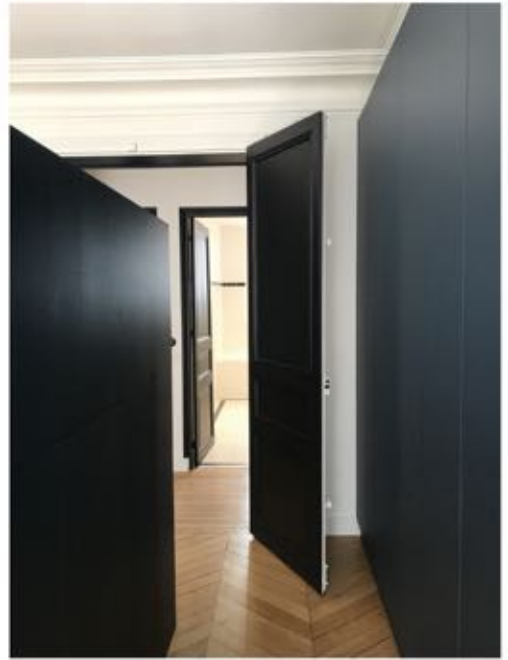

23, RUE POUCHET PARIS 17ème

111 m2 2

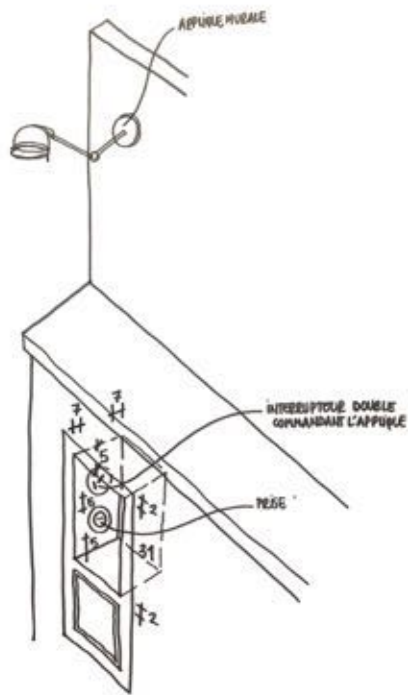

CROQUIS

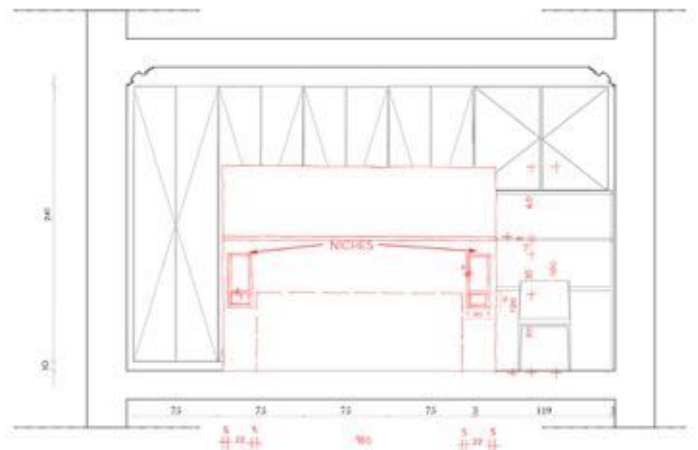

ELEVATION

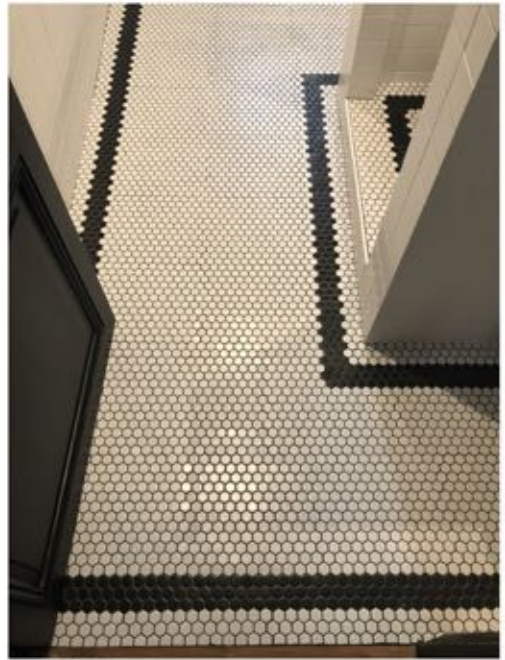

23, RUE POUCHET PARIS 17ème

111 m2

3

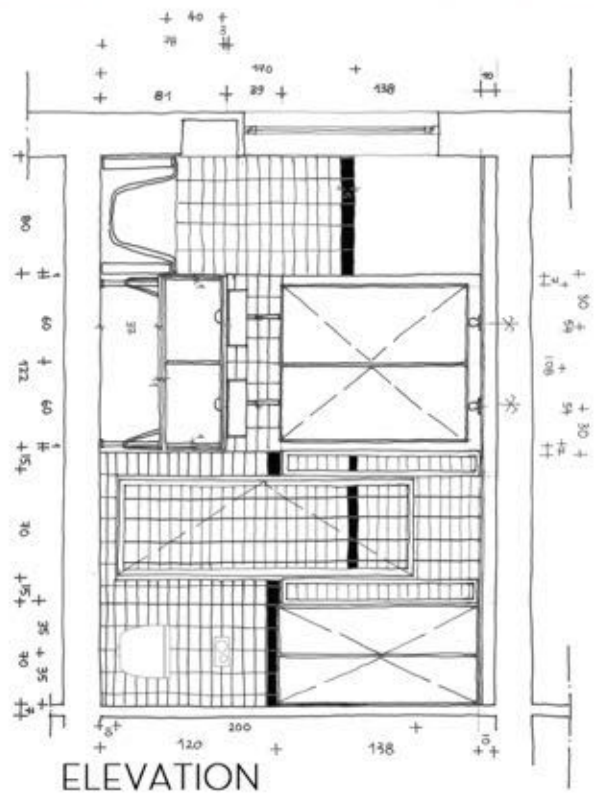
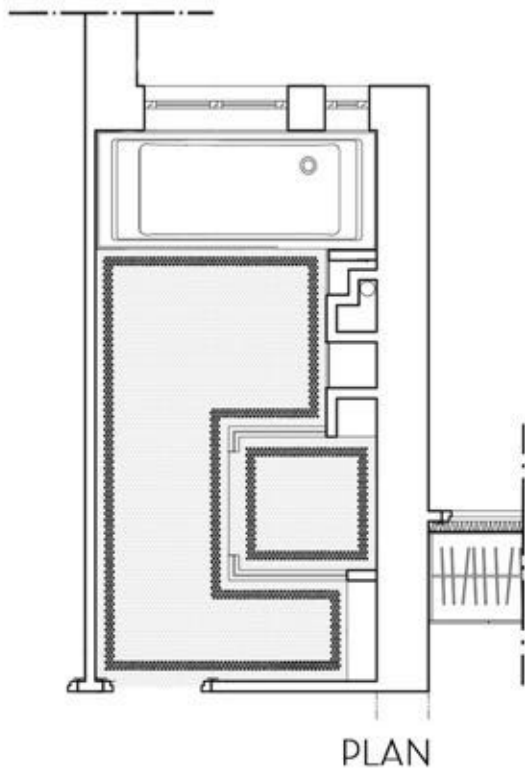

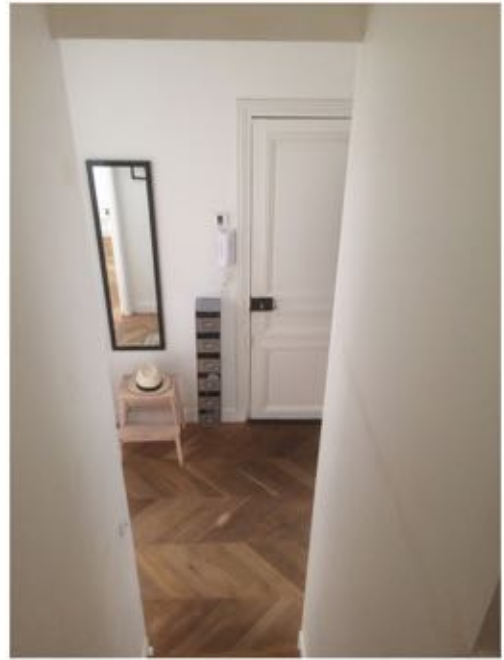

101, RUE BLOMET PARIS 15ème

130 m2 1

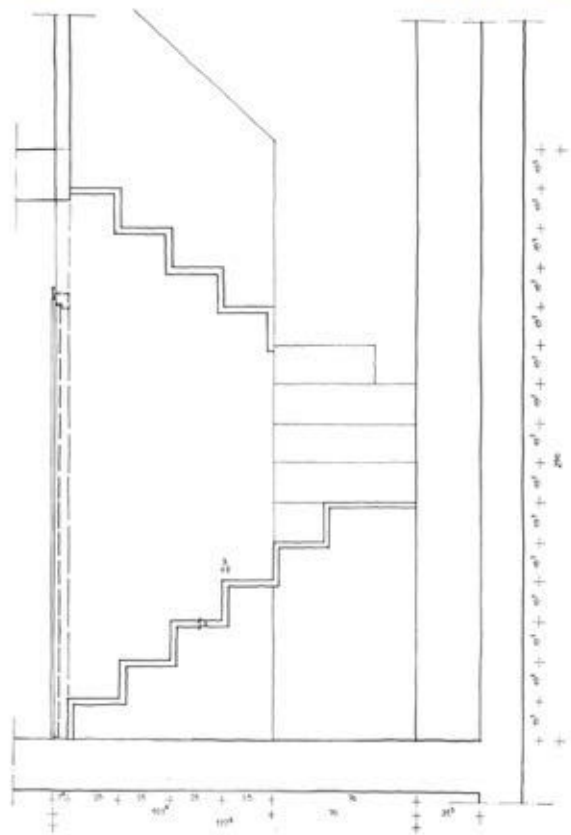
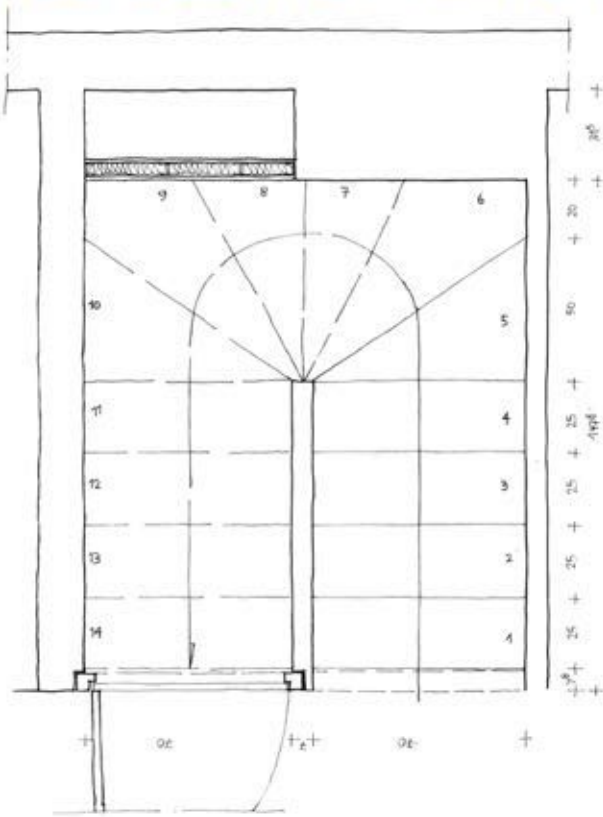



56, RUE DE MAUBEUGE PARIS 9ème

145 m2

1

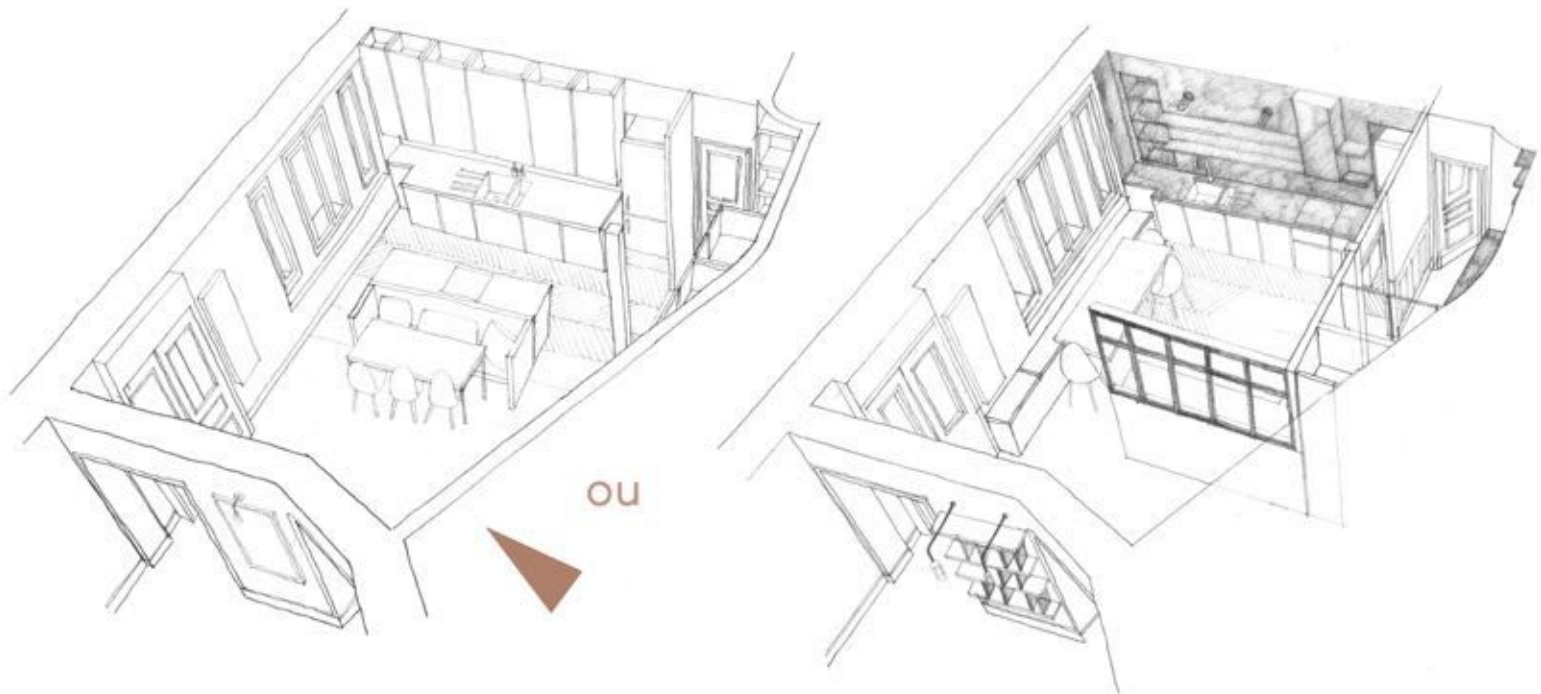



56, RUE DE MAUBEUGE PARIS 9ème

145 m2

2

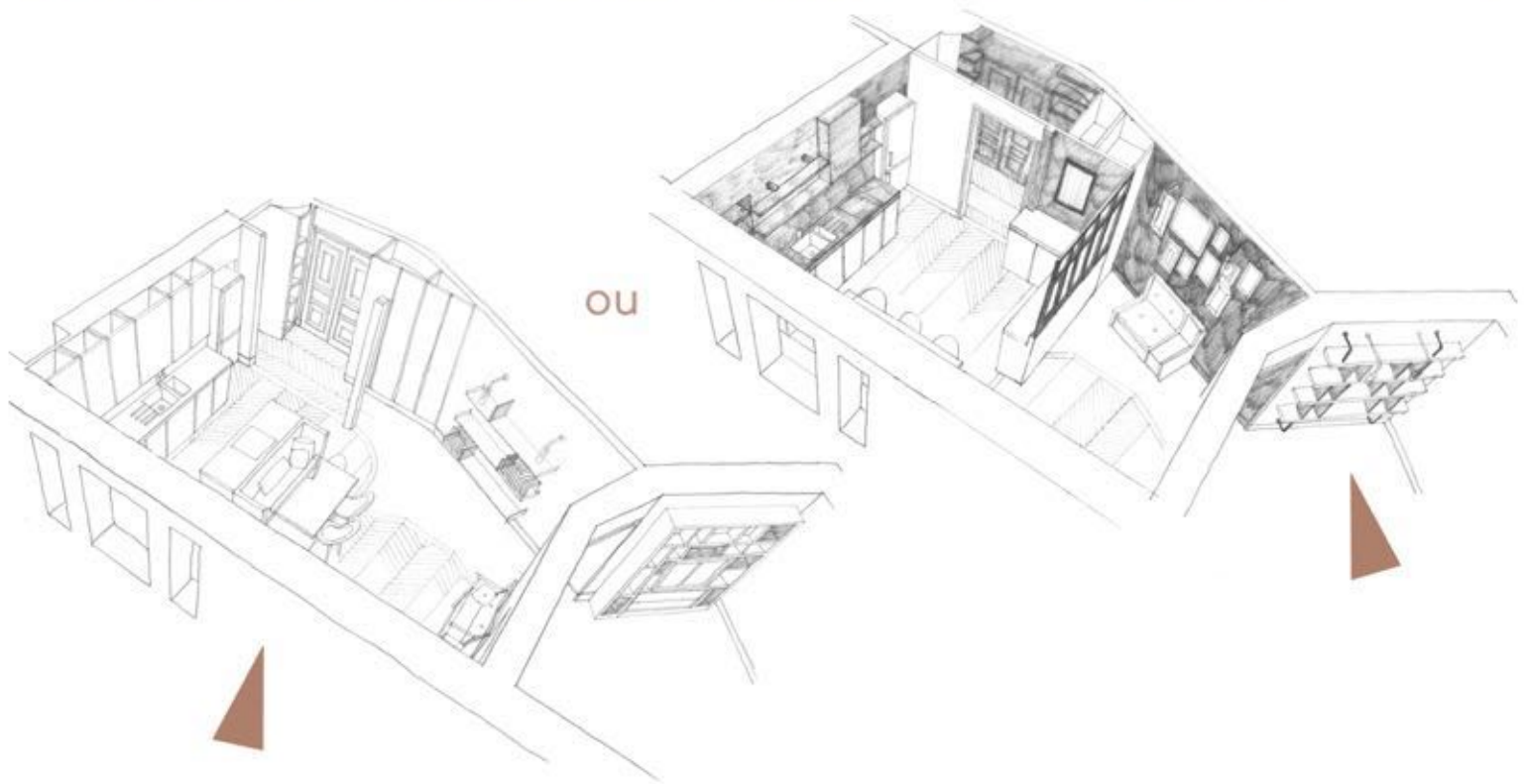



56, RUE DE MAUBEUGE PARIS 9ème

145 m2

3

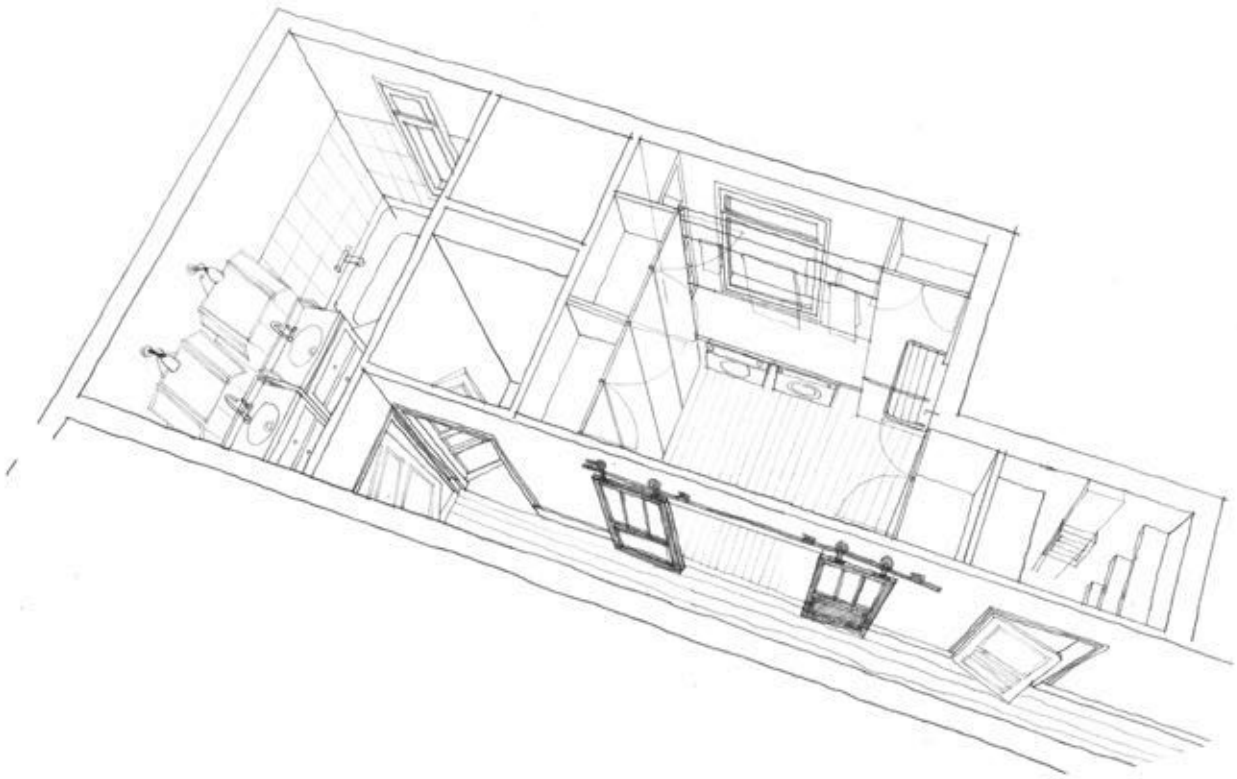



147, BOULEVARD MALESHERBES PARIS 16ème 74 m2 1

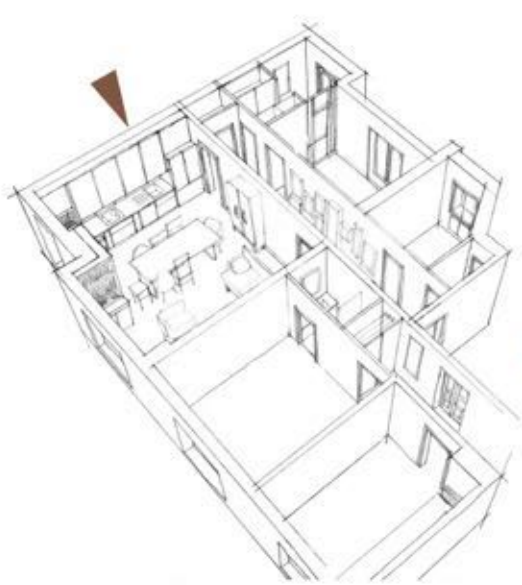

1

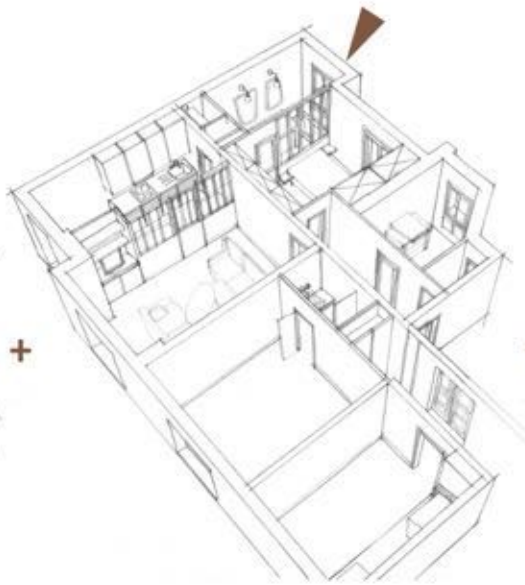

2

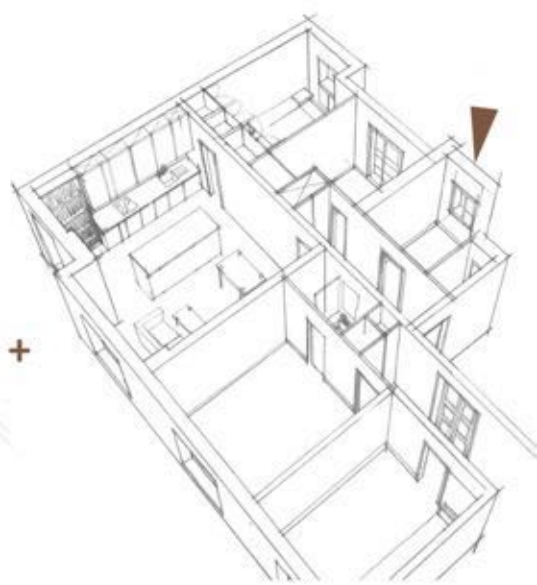

3

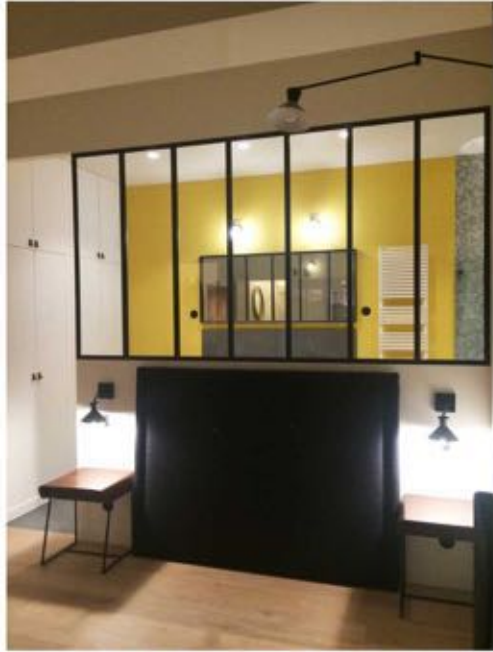

147, BOULEVARD MALESHERBES PARIS 16ème 74 m2 2

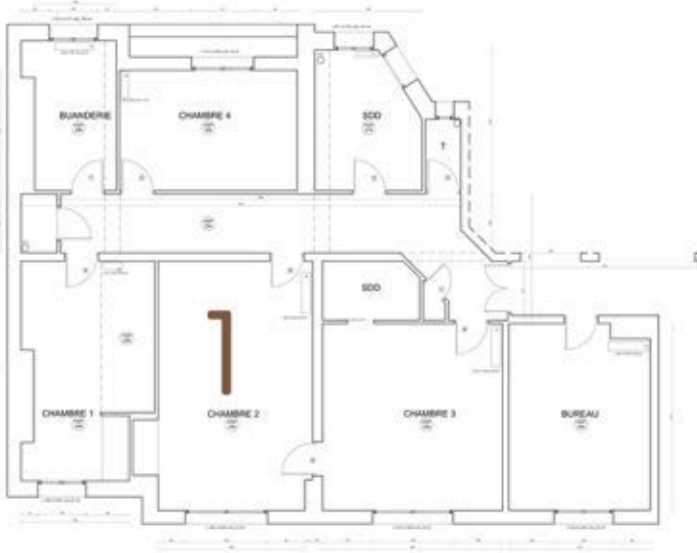

AVANT



APRES



147, BOULEVARD MALESHERBES PARIS 16ème 74 m2 3

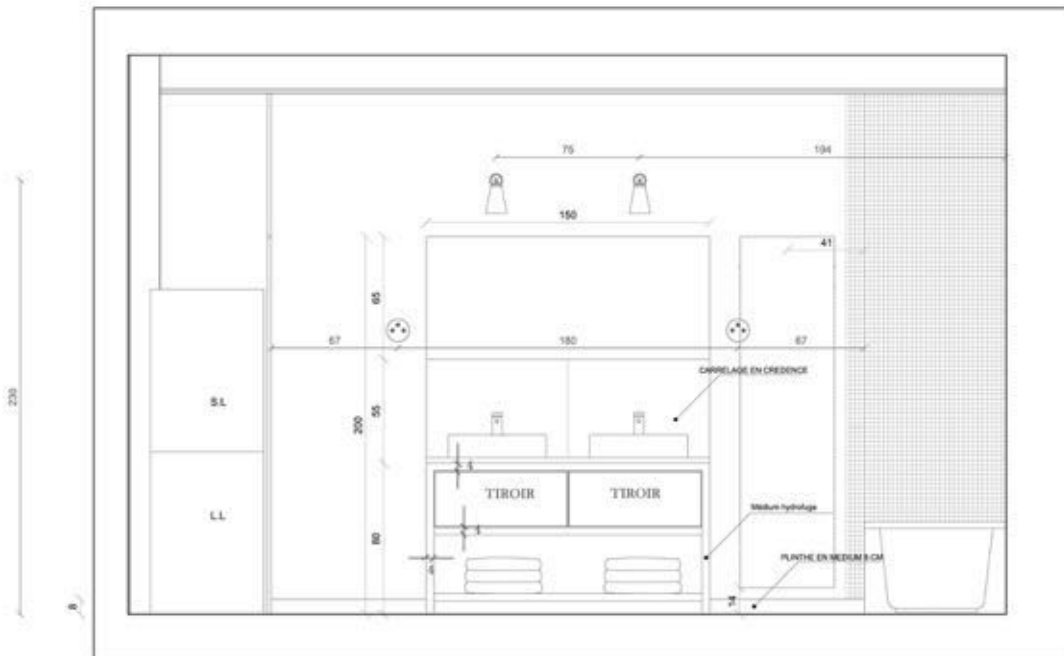



42, RUE DE TURBIGO PARIS 3ème 110 m2

1

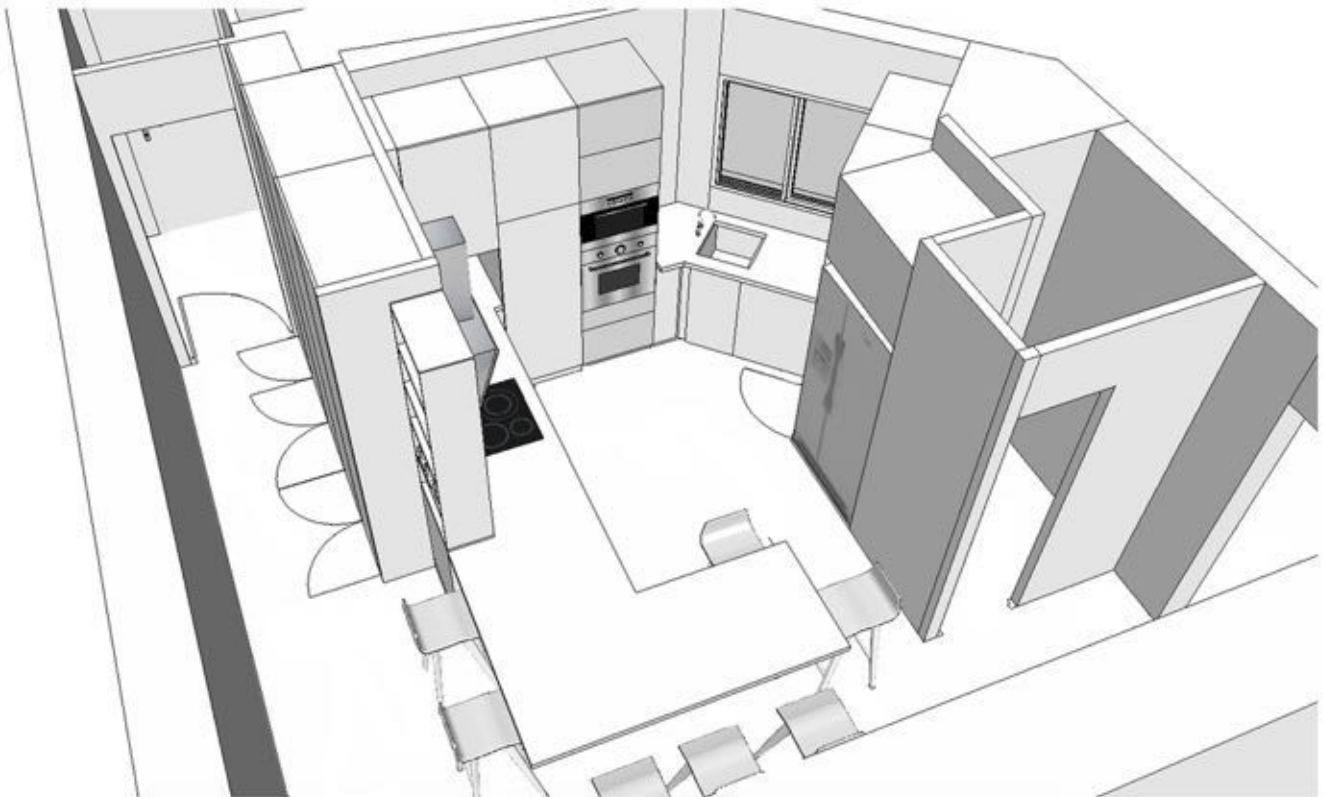



42, RUE DE TURBIGO PARIS 3ème 110 m2

2

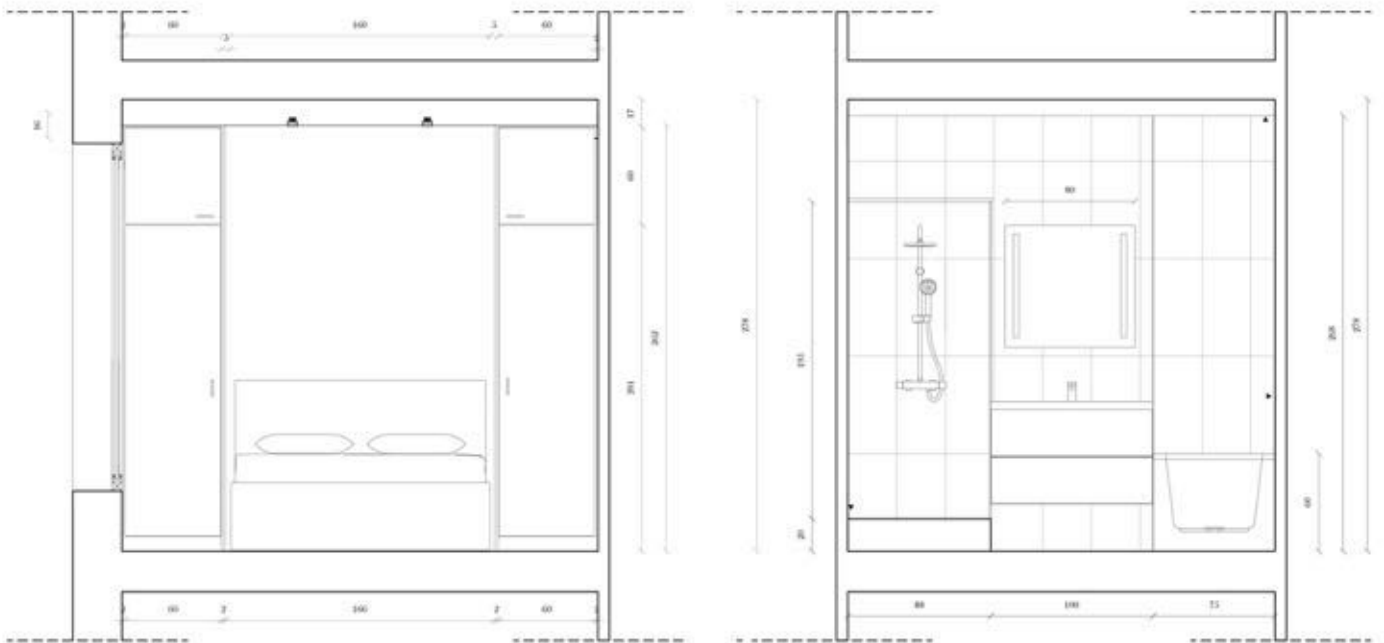



8. SQUARE THEOPHILE GAUTIER PARIS 16ème 84 m2 1

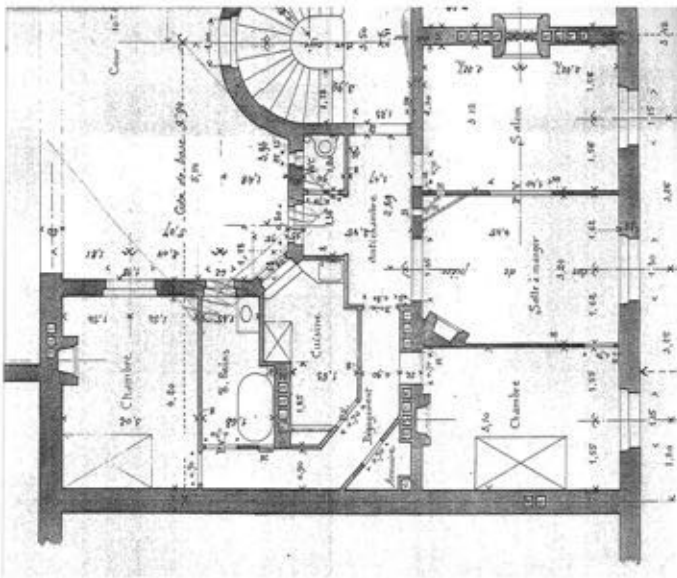

AVANT APRES

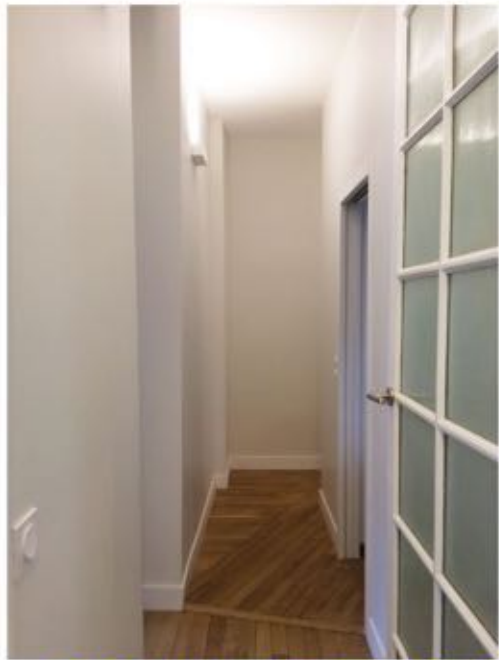

8, SQUARE THEOPHILE GAUTIER PARIS 16ème 84 m2 2

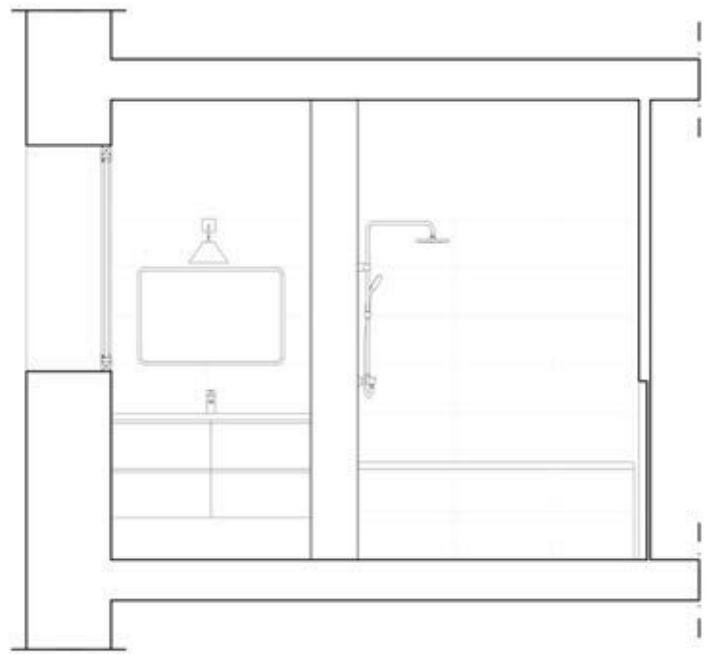
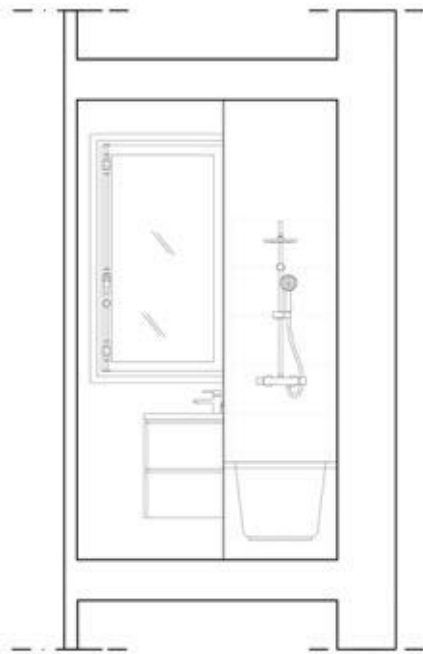



8. SQUARE THEOPHILE GAUTIER PARIS 16ème 84 m2 3

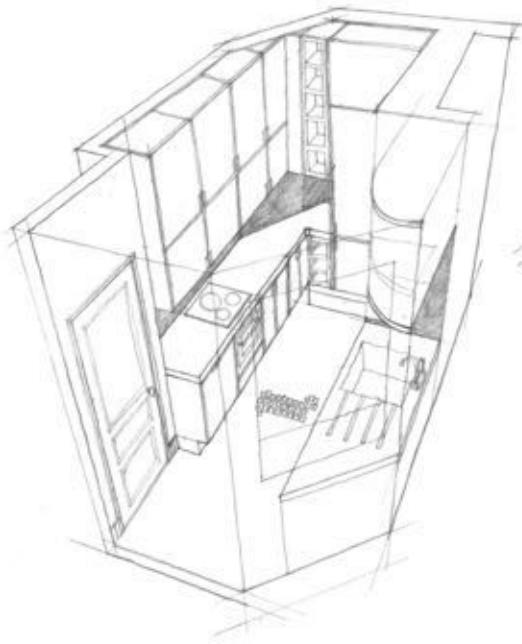

1

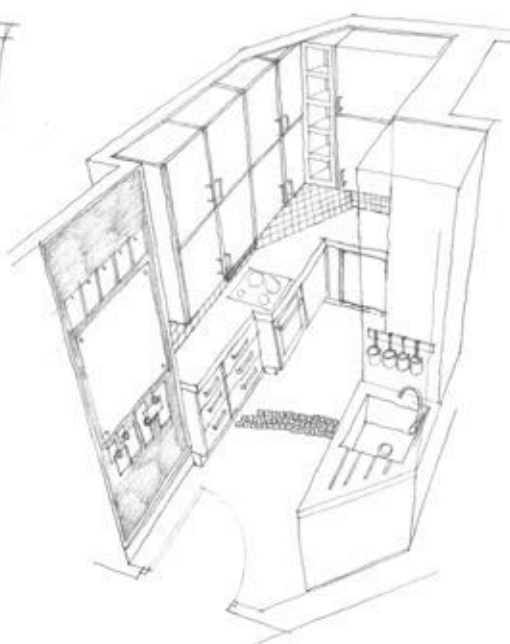

2

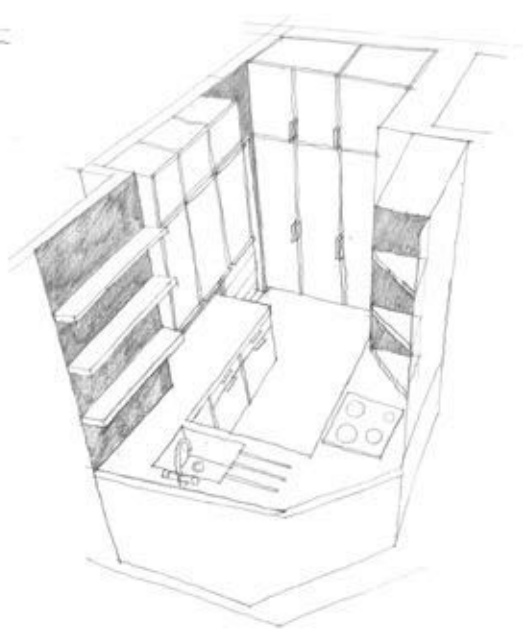

3

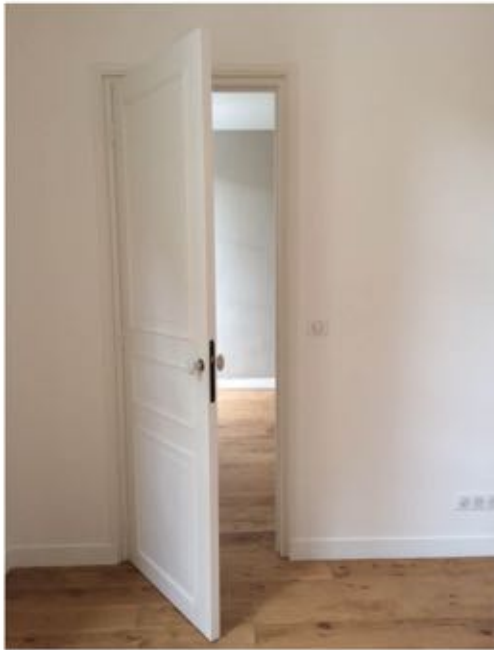

44, RUE POUSSIN PARIS 16ème 55 m2

1

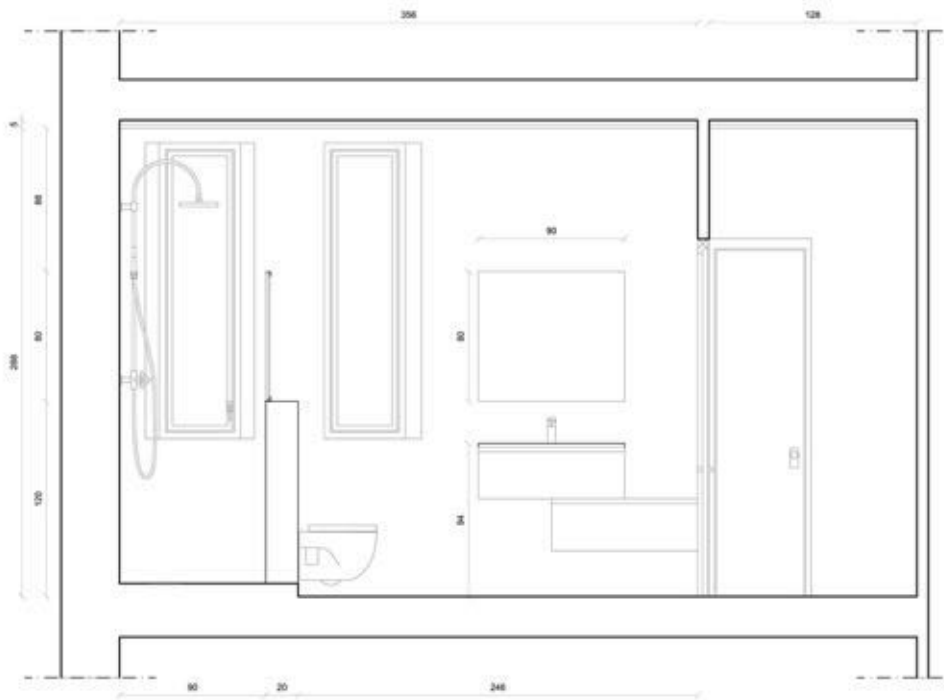

AA'

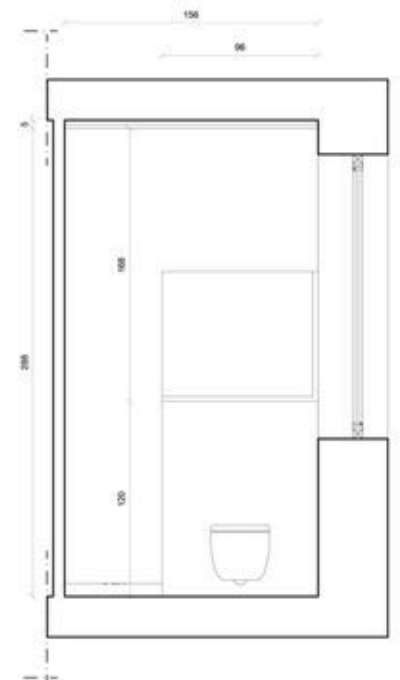

BB'



51, RUE DES ACACIAS PARIS 17ème

27 m2

1

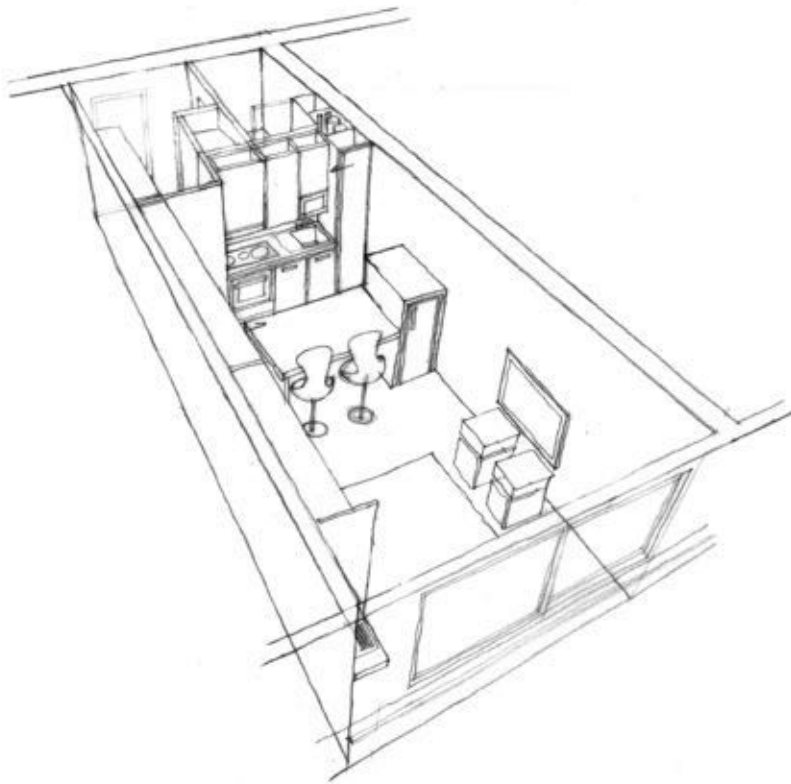



82, RUE MOUFFETARD PARIS 5ème

55 m2

1

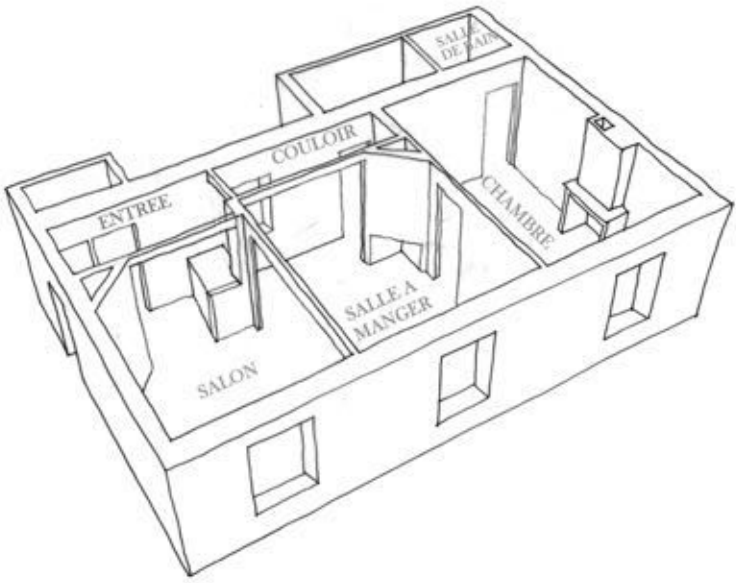
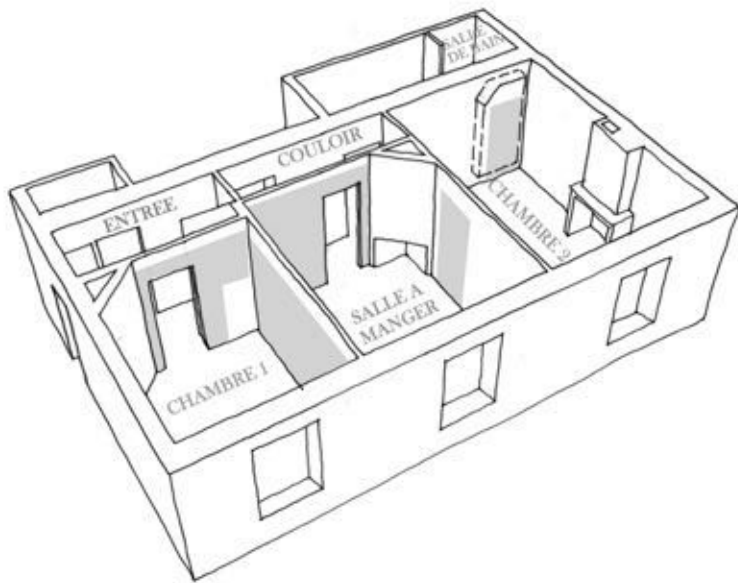

AVANT

APRES



262, RUE DE BELLEVILLE PARIS 20°

130 m2 1

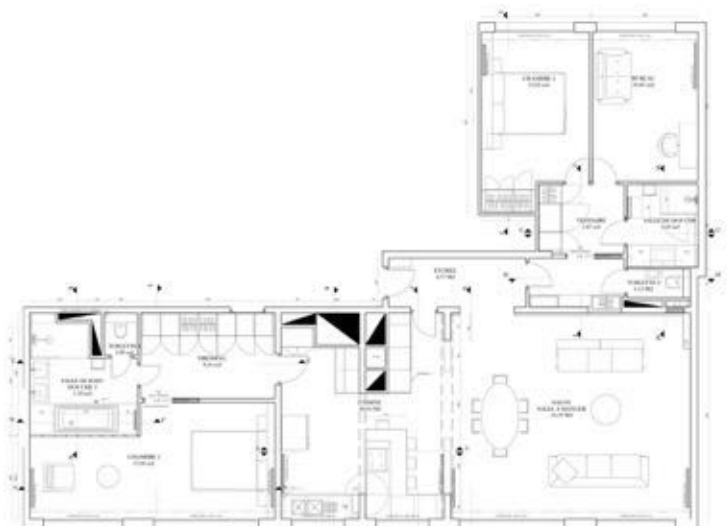
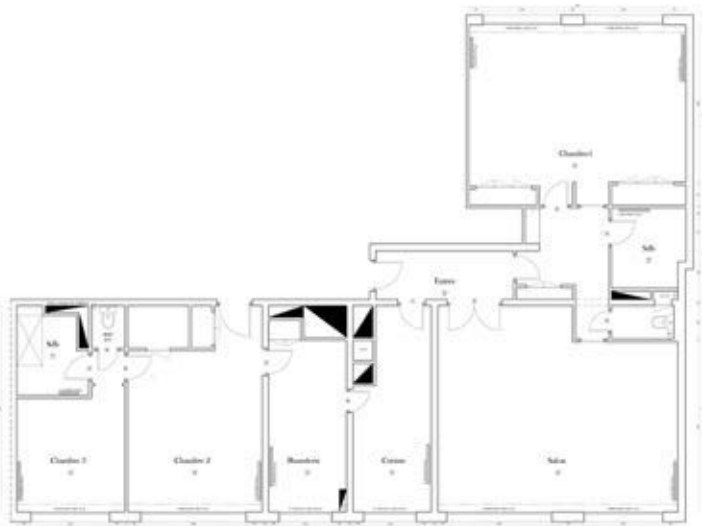

MURS PORTEURS



AMENAGEMENT AMENAGEMENT AMENAGEMENT



29, RUE DE BERNE PARIS 8ème

102 m2

1

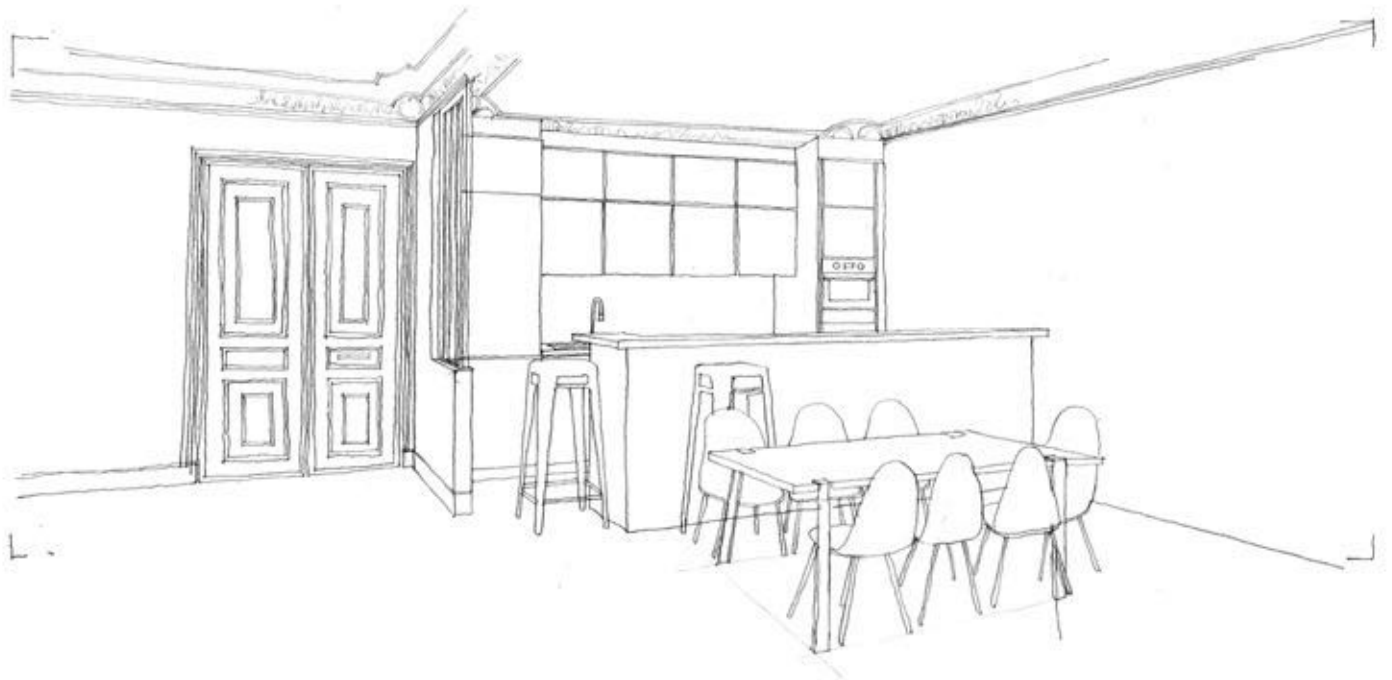



29, RUE DE BERNE PARIS 8ème

102 m2

2

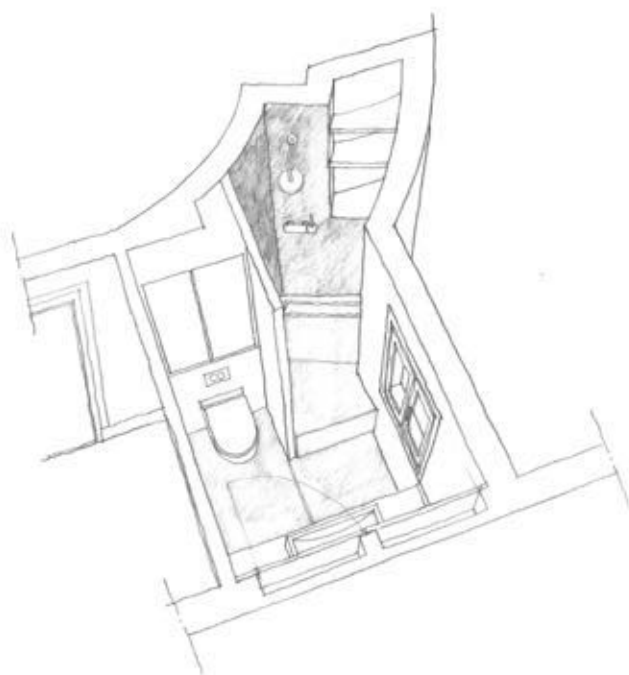
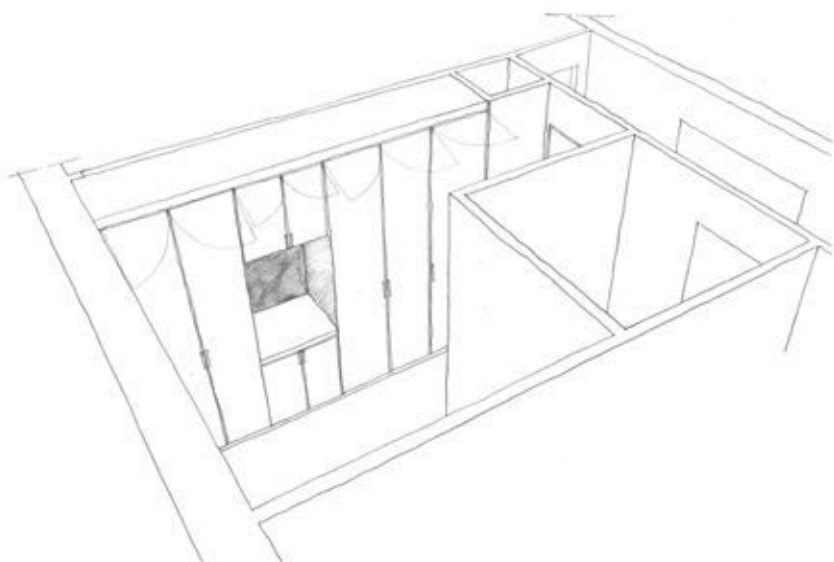



74, RUE BLANCHE PARIS 9ème

154 m2

1

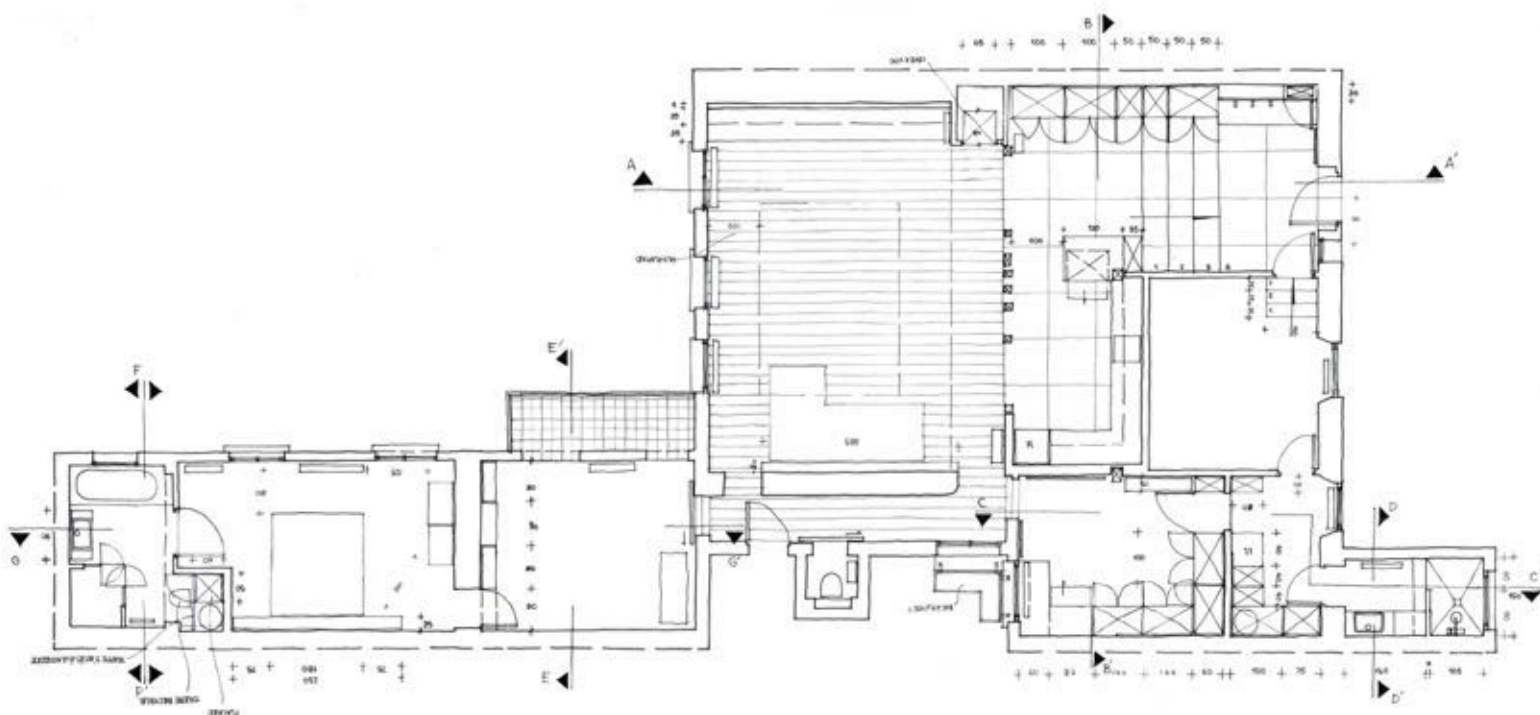



74, RUE BLANCHE PARIS 9ème

154 m²

2

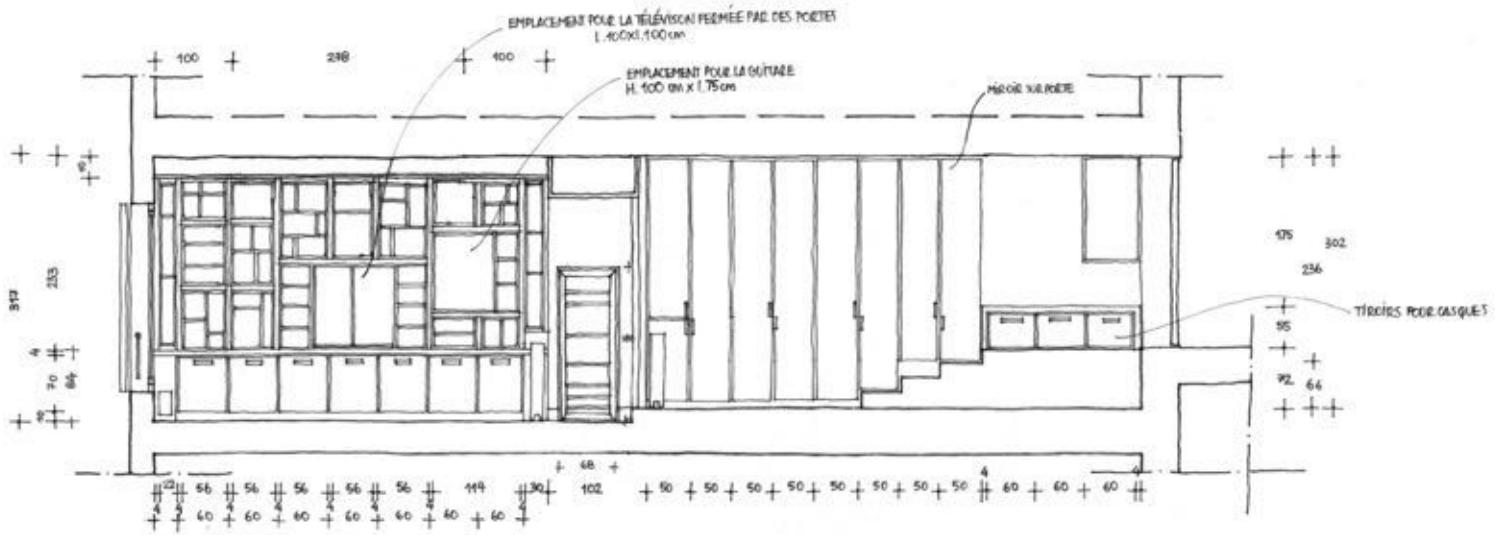



74, RUE BLANCHE PARIS 9ème

154 m2

3





MAISON CAP FERRET

1

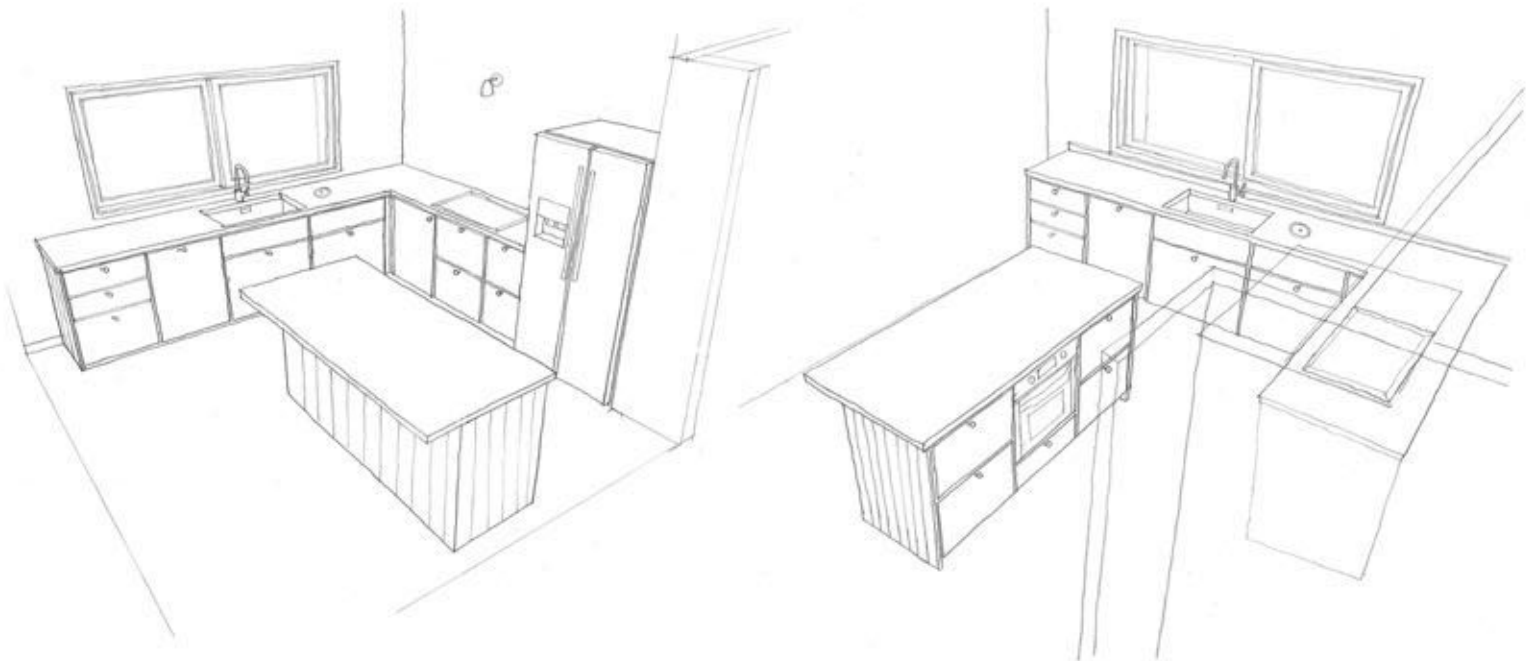

FACADE DE CUISINE,
SEED,
S3005-GeoY, BOCKLIP



CARRELAGE AU SOL
TERRAZZO,
MOSAIC DEL SUR,
YELLOW2, TB,
30 cm x 30 cm



PLAN DE TRAVAIL
COMPAQ

crédit photo: Billie Blanket



MAISON CAP FERRET

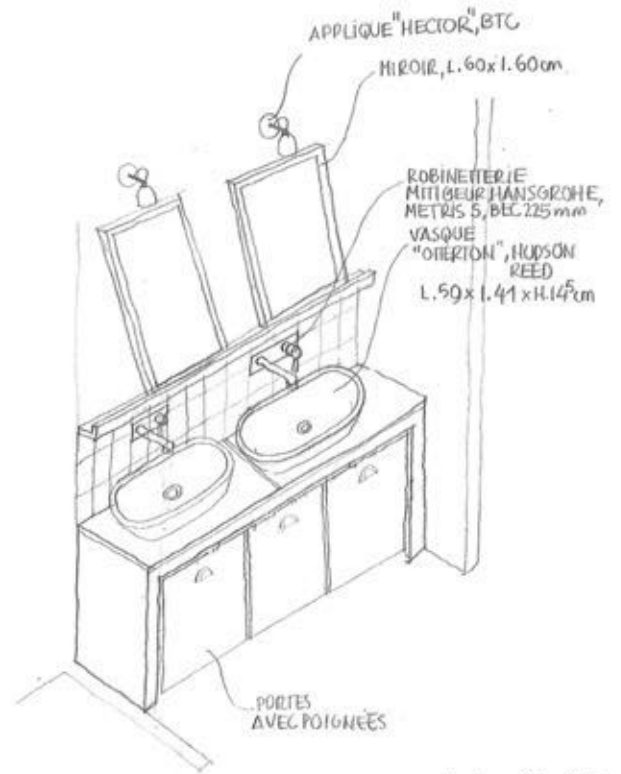
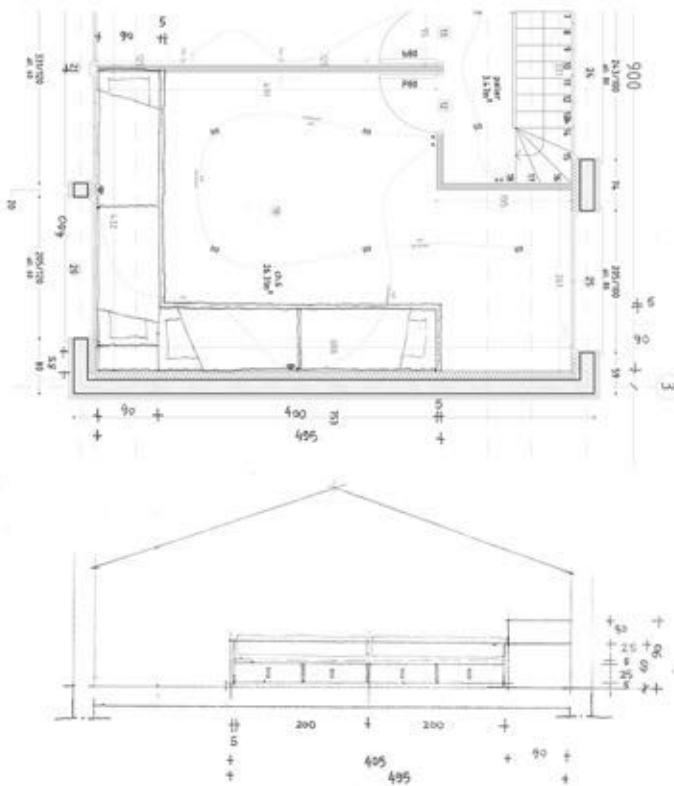

crédit photo: Billie Blanket



MAISON CAP FERRET

3

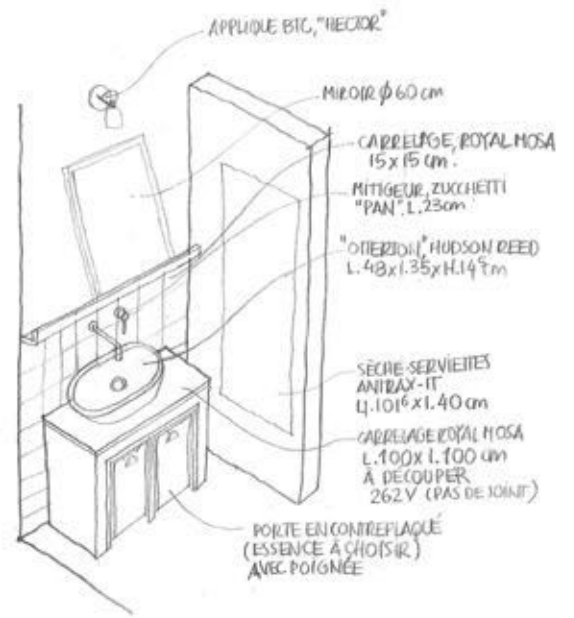
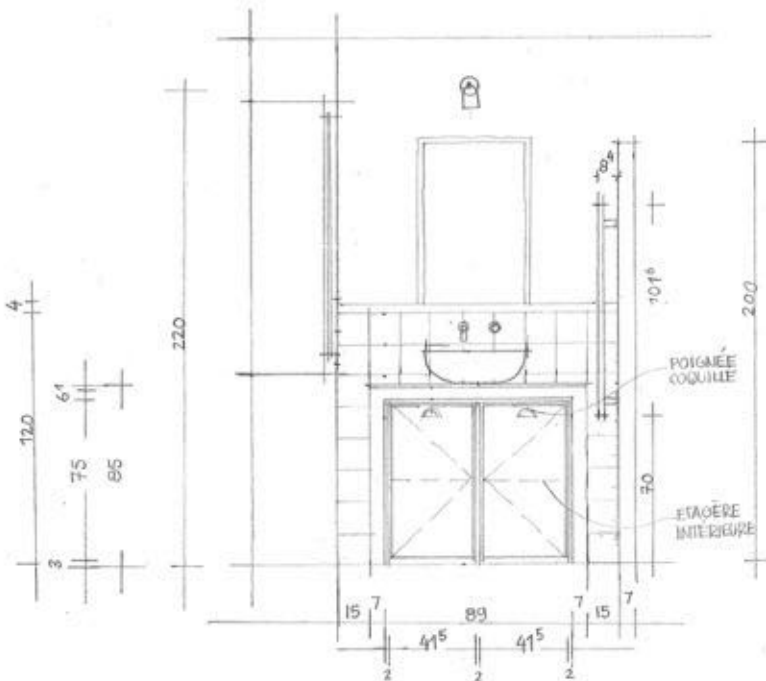

crédit photo: Billie Blanket



48, RUE G.DE CAVAINAC PARIS 11ème 90 m2 1

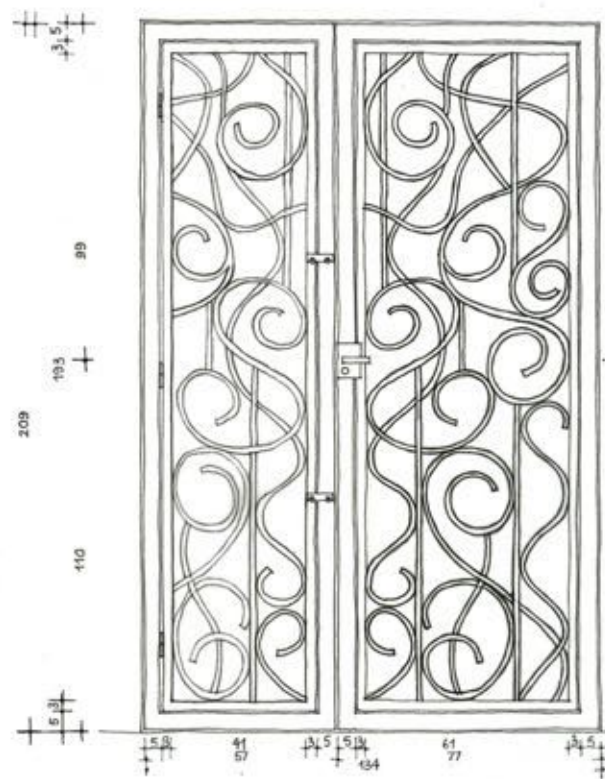

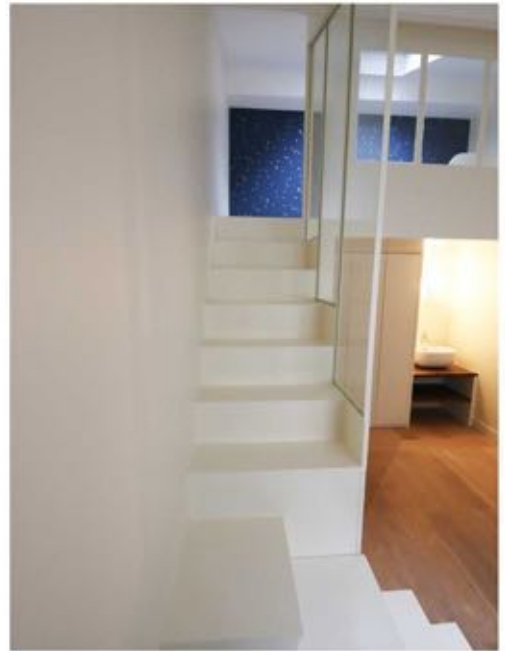

48, RUE G.DE CAVAINAC PARIS 11ème 90 m2 2

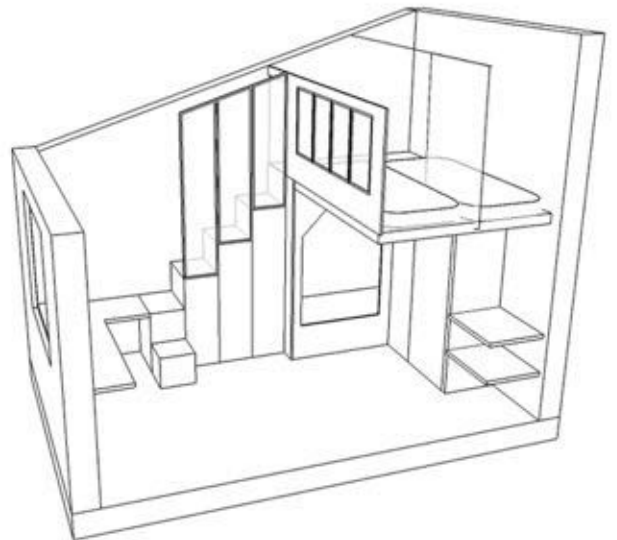
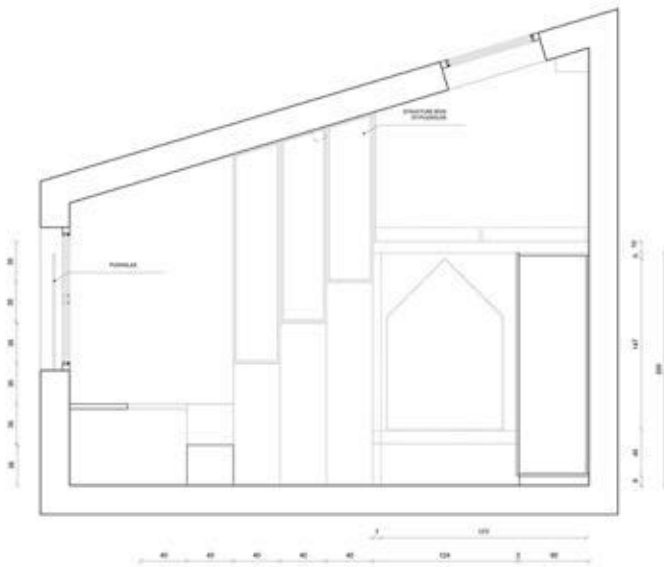

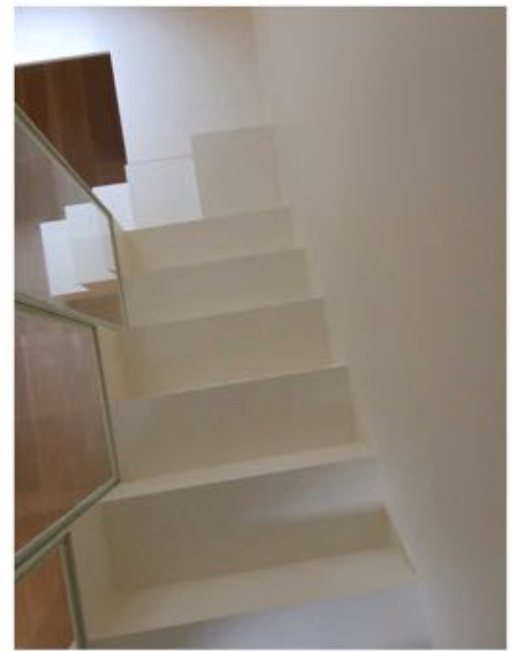

48, RUE G.DE CAVAINAC PARIS 11ème 90 m2 3

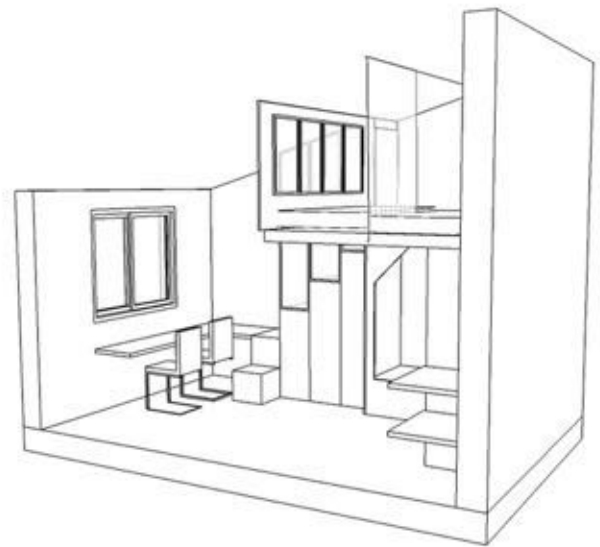
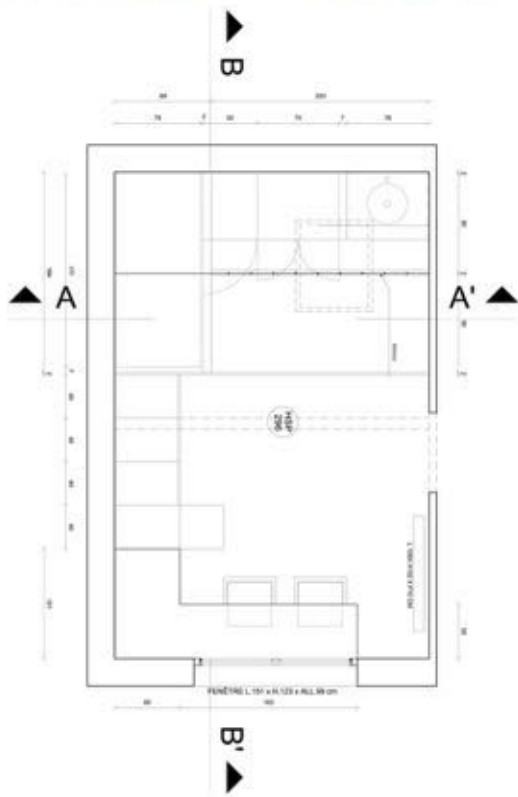



48, RUE G.DE CAVAINAC PARIS 11ème 90 m2 4

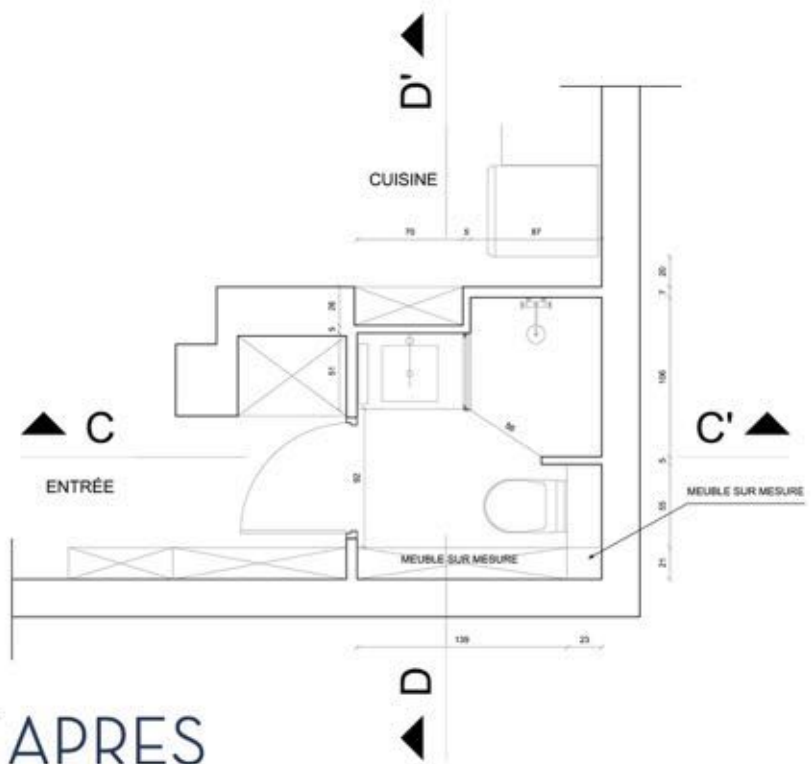
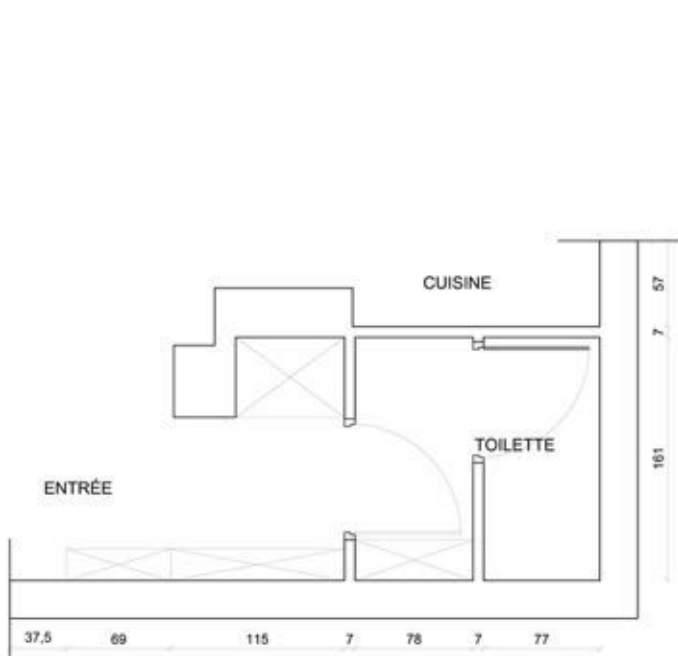

AVANT APRES



17, RUE FARADAY PARIS 17ème

130 m2

1

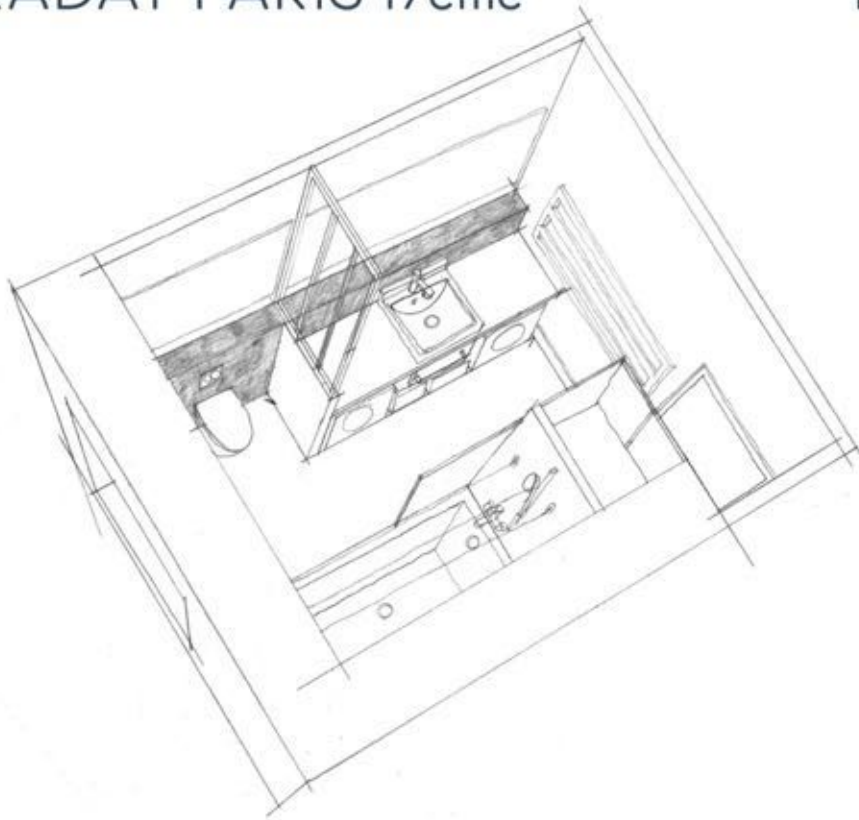

TENSION EXTENSION **EXTENSION** EXTENSION EXTE



6, RUE GUDIN PARIS 16ème

45 m2

1

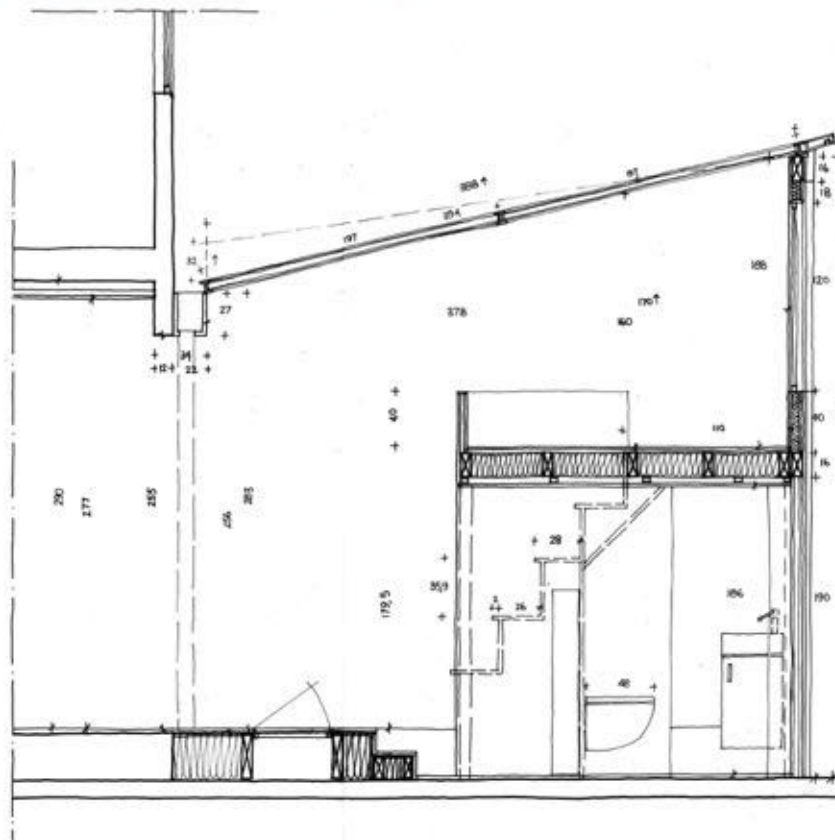



3, PLACE LAZARE CARNOT LIMOGES 230 m2

1

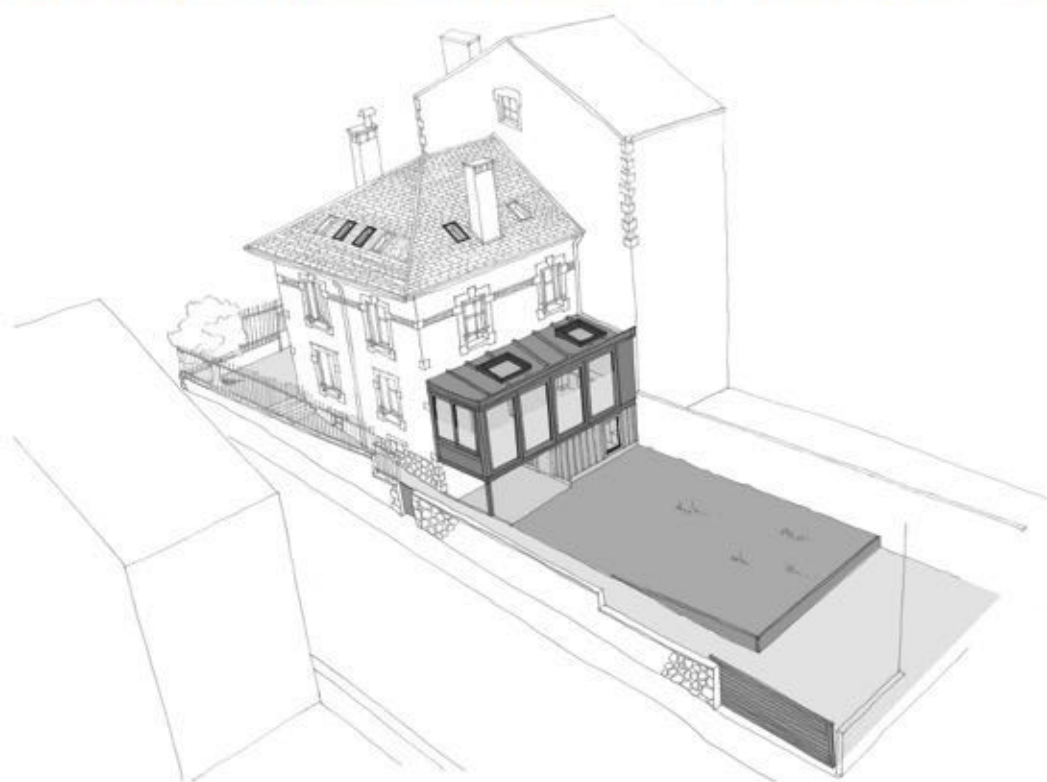

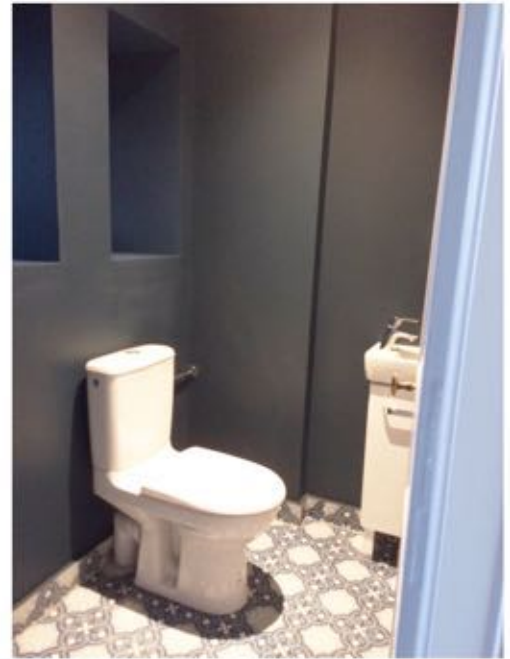
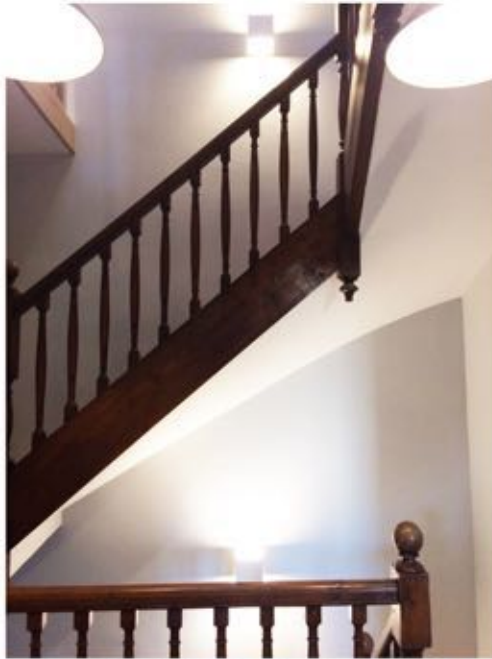

3, PLACE LAZARE CARNOT LIMOGES 230 m2 2

